

dbx[®]
by HARMAN

286s

Mic Preamp/Processor



User Manual

IMPORTANT SAFETY INFORMATION



The symbols shown above are internationally accepted symbols that warn of potential hazards with electrical products. The lightning flash with arrowpoint in an equilateral triangle means that there are dangerous voltages present within the unit. The exclamation point in an equilateral triangle indicates that it is necessary for the user to refer to the owner's manual.

These symbols warn that there are no user serviceable parts inside the unit. Do not open the unit. Do not attempt to service the unit yourself. Refer all servicing to qualified personnel. Opening the chassis for any reason will void the manufacturer's warranty. Do not get the unit wet. If liquid is spilled on the unit, shut it off immediately and take it to a dealer for service. Disconnect the unit during storms to prevent damage.

The following is indicative of low altitude use; do not use this product above 2000m.



U.K. MAINS PLUG WARNING

A molded mains plug that has been cut off from the cord is unsafe. Discard the mains plug at a suitable disposal facility.

NEVER UNDER ANY CIRCUMSTANCES SHOULD YOU INSERT A DAMAGED OR CUT MAINS PLUG INTO A 13 AMP POWER SOCKET.

Do not use the mains plug without the fuse cover in place. Replacement fuse covers can be obtained from your local retailer. Replacement fuses are 13 amps and **MUST** be ASTA approved to BS1362.



If you want to dispose this product, do not mix it with general household waste. There is a separate collection system for used electronic products in accordance with legislation that requires proper treatment, recovery and recycling.

Private households in the 25 member states of the EU, in Switzerland and Norway may return their used electronic products free of charge to designated collection facilities or to a retailer (if you purchase a similar new one).

For Countries not mentioned above, please contact your local authorities for a correct method of disposal.

By doing so you will ensure that your disposed product undergoes the necessary treatment, recovery and recycling and thus prevent potential negative effects on the environment and human health.

WARNING FOR YOUR PROTECTION READ THE FOLLOWING:

READ THESE INSTRUCTIONS.

KEEP THESE INSTRUCTIONS.

HEED ALL WARNINGS.

FOLLOW ALL INSTRUCTIONS.

DO NOT USE THIS APPARATUS NEAR WATER.

CLEAN ONLY WITH A DRY CLOTH.

FOR INDOOR USE ONLY.

DO NOT BLOCK ANY OF THE VENTILATION OPENINGS. INSTALL IN ACCORDANCE WITH THE MANUFACTURER'S INSTRUCTIONS.

DO NOT INSTALL NEAR ANY HEAT SOURCES SUCH AS RADIATORS, HEAT REGISTERS, STOVES, OR OTHER APPARATUS (INCLUDING AMPLIFIERS) THAT PRODUCE HEAT.

ONLY USE ATTACHMENTS/ACCESSORIES SPECIFIED BY THE MANUFACTURER.

UNPLUG THIS APPARATUS DURING LIGHTNING STORMS OR WHEN UNUSED FOR LONG PERIODS OF TIME.

Do not defeat the safety purpose of the polarized or grounding-type plug. A polarized plug has two blades with one wider than the other. A grounding type plug has two blades and a third grounding prong. The wide blade or third prong are provided for your safety. If the provided plug does not fit your outlet, consult an electrician for replacement of the obsolete outlet.

Protect the power cord from being walked on or pinched particularly at plugs, convenience receptacles, and the point where they exit from the apparatus.

Use only with the cart stand, tripod bracket, or table specified by the manufacture, or sold with the apparatus. When a cart is used, use caution when moving the cart/apparatus combination to avoid injury from tip-over.



Refer all servicing to qualified service personnel. Servicing is required when the apparatus has been damaged in any way, such as power-supply cord or plug is damaged, liquid has been spilled or objects have fallen into the apparatus, the apparatus has been exposed to rain or moisture, does not operate normally, or has been dropped.

POWER ON/OFF SWITCH: The Power switch used in this piece of equipment **DOES NOT** break the connection from the mains.

MAINS DISCONNECT: The plug shall remain readily operable. For rack-mount or installation where plug is not accessible, an all-pole mains switch with a contact separation of at least 3 mm in each pole shall be incorporated into the electrical installation of the rack or building.

If connected to 240V supply, a suitable CSA/UL certified power cord shall be used for this supply.

This equipment is intended for rack mount use only.

IMPORTANT SAFETY INFORMATION

SAFETY INSTRUCTIONS

NOTICE FOR CUSTOMERS IF YOUR UNIT IS EQUIPPED WITH A POWER CORD.

WARNING: THIS APPLIANCE SHALL BE CONNECTED TO A MAINS SOCKET OUTLET WITH A PROTECTIVE EARTHING CONNECTION.

THE CORES IN THE MAINS LEAD ARE COLOURED IN ACCORDANCE WITH THE FOLLOWING CODE:

GREEN AND YELLOW - EARTH BLUE - NEUTRAL BROWN - LIVE

AS COLOURS OF THE CORES IN THE MAINS LEAD OF THIS APPLIANCE MAY NOT CORRESPOND WITH THE COLOURED MARKINGS IDENTIFYING THE TERMINALS IN YOUR PLUG, PROCEED AS FOLLOWS:

- THE CORE WHICH IS COLOURED GREEN AND YELLOW MUST BE CONNECTED TO THE TERMINAL IN THE PLUG MARKED WITH THE LETTER E, OR WITH THE EARTH SYMBOL, OR COLOURED GREEN, OR GREEN AND YELLOW.
- THE CORE WHICH IS COLOURED BLUE MUST BE CONNECTED TO THE TERMINAL MARKED N OR COLOURED BLACK.
- THE CORE WHICH IS COLOURED BROWN MUST BE CONNECTED TO THE TERMINAL MARKED L OR COLOURED RED.

THIS EQUIPMENT MAY REQUIRE THE USE OF A DIFFERENT LINE CORD, ATTACHMENT PLUG, OR BOTH, DEPENDING ON THE AVAILABLE POWER SOURCE AT INSTALLATION. IF THE ATTACHMENT PLUG NEEDS TO BE CHANGED, REFER SERVICING TO QUALIFIED SERVICE PERSONNEL WHO SHOULD REFER TO THE TABLE BELOW. THE GREEN/YELLOW WIRE SHALL BE CONNECTED DIRECTLY TO THE UNITS CHASSIS.

CONDUCTOR		WIRE COLOR	
		Normal	Alt
L	LIVE	BROWN	BLACK
N	NEUTRAL	BLUE	WHITE
E	EARTH GND	GREEN/YEL	GREEN

WARNING: IF THE GROUND IS DEFEATED, CERTAIN FAULT CONDITIONS IN THE UNIT OR IN THE SYSTEM TO WHICH IT IS CONNECTED CAN RESULT IN FULL LINE VOLTAGE BETWEEN CHASSIS AND EARTH GROUND. SEVERE INJURY OR DEATH CAN THEN RESULT IF THE CHASSIS AND EARTH GROUND ARE TOUCHED SIMULTANEOUSLY.

WARNING:

- APPARATET MÅ TILKOPLES JORDET STIKKONTAKT.
- APPARATEN SKALL ANSLUTAS TILL JORDAT UTTAG.
- LAITE ON LIITETTÄVÄ SUOJAKOSKETTIMILLA VARUSTETTUUN PISTORASIAAN.
- APPARATET SKAL TILSLUTTES JORDET STIKKONTAKT.

DECLARATION OF CONFORMITY

declares that the product:

Product name: dbx286S

Note: Product name may be suffixed by a combination of the letters EU, M, or V.

Product option: None

conforms to the following Product Specifications:

Safety: IEC 60065 -01+Amd 1

EMC: EN 55022:2010 (N/A, analog product)
EN 55024:2010 + EN61000-3-2 + EN61000-3-3
FCC Part 15 (N/A, analog product)

Supplementary Information:

The product herewith complies with the requirements of the:
Low Voltage Directive 2014/35/EU
EMC Directive 2014/30/EU
RoHS Directive 2011/65/EU
WEEE Directive 2012/19/EU

With regard to Directive 2005/32/EC and EC Regulation 1275/2008 of 17 December 2008, this product is designed, produced, and classified as Professional Audio Equipment and thus is exempt from this Directive.

European Contact:

or

CONSIGNES DE SÉCURITÉ IMPORTANTES

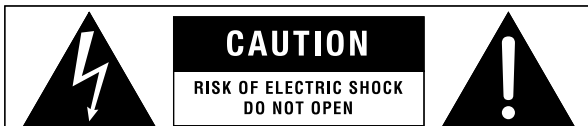

ATTENTION: RISQUE DE CHOC ÉLECTRIQUE - NE PAS OUVRIR

WARNING: TO REDUCE THE RISK OF FIRE OR ELECTRIC SHOCK DO NOT EXPOSE THIS EQUIPMENT TO RAIN OR MOISTURE

ATTENTION: POUR RÉDUIRE LE RISQUE D'INCENDIE OU D'ÉLECTROCUTION N'EXPOSEZ PAS CET APPAREIL À LA PLUIE OU L'HUMIDITÉ

Les symboles illustrés ci-dessus sont des symboles acceptés internationalement qui avertissent des dangers potentiels relatifs à l'utilisation de produits électriques. Le voyant clignotant avec une flèche dans un triangle équilatéral signifie la présence de tensions dangereuses dans l'appareil. Le point d'exclamation dans un triangle équilatéral indique que l'utilisateur doit se référer au manuel d'utilisation.

Ces symboles indiquent qu'il n'y a aucune pièce utilisable par l'utilisateur à l'intérieur de l'appareil. Ne pas ouvrir l'appareil. Ne pas essayer de réparer soi-même l'appareil. Confier toute réparation à du personnel qualifié. Ouvrir la structure de l'appareil pour quelque raison que ce soit annulera la garantie du fabricant. Ne pas mouiller l'appareil. Si du liquide est renversé sur l'appareil, fermer immédiatement l'appareil et l'apporter chez un réparateur. Débrancher l'appareil pendant les tempêtes afin d'éviter des dommages.

Ce qui suit est représentatif d'une utilisation à basse altitude ; ne pas utiliser ce produit au-dessus de 2000 m.



AVERTISSEMENT CONCERNANT LA FICHE SECTEUR

Une fiche secteur moulée qui a été coupée du cordon est dangereuse. Jeter la fiche secteur dans un centre de déchets adapté.

VOUS NE DEVEZ EN AUCUNE CIRCONSTANCE INSÉRER UNE FICHE ENDOMMAGÉE OU COUPÉE DANS UNE PRISE SECTEUR 13 AMP.

Ne pas utiliser la fiche secteur si le couvercle du coffret à fusibles n'est pas bien en place. Vous pouvez vous procurer des capots de fusible de rechange auprès de votre détaillant local. Les fusibles de remplacement sont de 13 A et DOIVENT être approuvés ASTA, BS1362.



Ne pas jeter ce produit avec les ordures ménagères. Il existe un système de collecte sélective pour les produits électroniques usagés en conformité avec les lois en vigueur en matière de traitement, de récupération et de recyclage.

Dans les 25 États membres de l'UE, en Norvège et en Suisse, les ménages peuvent envoyer leurs produits électroniques usagés sans frais vers des centres de collecte sélective ou chez un distributeur (contre l'achat d'un nouveau produit).

Contactez les autorités locales pour connaître les procédures de traitement des déchets adoptées dans les pays non mentionnés ci-dessus.

Non seulement cette précaution vous permettra d'être sûr que votre produit est correctement traité, récupéré et recyclé, mais elle vous évitera également de nuire involontairement à l'environnement et à la santé humaine.

AVERTISSEMENT POUR VOTRE SÉCURITÉ LIRE ATTENTIVEMENT :

LIRE CES CONSIGNES.

CONSERVER CES CONSIGNES.

RESPECTER TOUS LES AVERTISSEMENTS.

SUIVRE TOUTES LES CONSIGNES.

NE PAS UTILISER CET APPAREIL PRÈS DE L'EAU.

NETTOYER UNIQUEMENT AVEC UN CHIFFON SEC.

POUR USAGE INTÉRIEUR UNIQUEMENT.

NE PAS OBSTRUER LES OUIÈS D'AÉRATION. EFFECTUER L'INSTALLATION CONFORMÉMENT AUX INSTRUCTIONS DU FABRICANT.

NE PAS INSTALLER À PROXIMITÉ DE SOURCES DE CHALEUR TELLES QUE DES RADIATEURS, BOUCHES D'AÉRATION, PLAQUES CHAUFFANTES OU TOUT AUTRE APPAREIL (Y COMPRIS DES AMPLIFICATEURS) DÉGAGEANT DE LA CHALEUR.

UTILISER UNIQUEMENT LES PIÈCES/ACCESSOIRES MENTIONNÉS PAR LE FABRICANT.

DÉBRANCHER L'APPAREIL AU COURS DES ORAGES OU EN CAS DE NON-UTILISATION PENDANT UNE DURÉE PROLONGÉE.

Ne pas détériorer la sécurité de la fiche polarisée ou de la fiche de terre. Les fiches polarisées sont équipées de deux bornes de largeurs différentes. Les fiches de terre comportent deux lames et une troisième broche de mise à la terre. La broche la plus large ou troisième broche de mise à la terre est prévue pour votre sécurité. Si la fiche fournie ne correspond pas à votre installation électrique, faire appel à un électricien pour remplacer la prise hors normes.

Protéger le cordon d'alimentation contre les risques de piétinement ou de pincement, notamment au niveau des fiches, des prises de courant et du point d'attache avec le matériel.

Utiliser uniquement le chariot, le support, le trépied ou la table spécifié(e) par le fabricant ou vendu(e) avec le matériel. Si vous utilisez un chariot pour déplacer l'appareil, soyez suffisamment prudent pour éviter une éventuelle blessure consécutive au basculement du chariot et de sa charge.



Les réparations doivent être confiées à un technicien S.A.V. qualifié. Une réparation est nécessaire en cas de dommage quelconque et en particulier en cas d'endommagement du cordon d'alimentation ou de la fiche électrique, d'infiltration liquide, d'introduction involontaire d'un objet dans l'appareil, d'exposition de l'appareil à la pluie ou à un milieu humide, de fonctionnement anormal ou de chute de l'appareil.

INTERRUPTEUR MARCHÉ/ARRÊT : l'interrupteur d'alimentation de cet équipement NE coupe PAS la connexion secteur.

DÉBRANCHEMENT DE L'APPAREIL : la prise de courant doit rester facilement accessible. Pour un montage en rack ou une installation avec une prise inaccessible, un interrupteur omnipolaire à distance d'ouverture de contact d'au moins 3 mm doit être intégré à l'installation électrique du rack ou du local.

Si le matériel est relié à une alimentation de 240 V, utiliser impérativement un cordon d'alimentation adapté certifié CSA/UL pour ce branchement.

Cet équipement est exclusivement destiné à un montage en rack.

CONSIGNES DE SÉCURITÉ IMPORTANTES

CONSIGNES DE SÉCURITÉ

NOTICE ADRESSÉE AUX CONSOMMATEURS ÉQUIPÉS D'UN MATÉRIEL AVEC CORDON D'ALIMENTATION FOURNI.

AVERTISSEMENT : CET APPAREIL DOIT ÊTRE BRANCHÉ SUR UNE PRISE SECTEUR DOTÉE D'UNE PROTECTION PAR MISE À LA TERRE.

LES COULEURS DES NOYAUX DANS LES FILS SECTEURS DOIVENT RESPECTER LES CODES SUIVANTS :

VERT ET JAUNE - TERRE BLEU - NEUTRE MARRON - PHASE

LES COULEURS DES NOYAUX DANS LES FILS SECTEURS DE CET APPAREIL PEUVENT NE PAS CORRESPONDE AUX INSCRIPTIONS COLORÉES IDENTIFIANT LES TERMINAUX DANS VOTRE FICHE ; IL FAUT DONC PROCÉDER DE LA FAÇON SUIVANTE :

- LE NOYAU VERT ET JAUNE DOIT ÊTRE BRANCHÉ AU TERMINAL DE LA FICHE OÙ APPARAÎT LA LETTRE E OU LE SYMBOLE DE MISE À LA TERRE, OU AU TERMINAL VERT OU VERT ET JAUNE.
- LE NOYAU BLEU DOIT ÊTRE BRANCHÉ AU TERMINAL MARQUÉ D'UN N OU DE COULEUR NOIRE.
- LE NOYAU MARRON DOIT ÊTRE BRANCHÉ AU TERMINAL MARQUÉ D'UN L OU DE COULEUR ROUGE.

CE MATÉRIEL PEUT NéCESSITER L'UTILISATION D'UN CORDON D'ALIMENTATION DIFFÉRENT ET/OU D'UNE FICHE DE BRANCHEMENT DIFFÉRENTE SELON LA SOURCE D'ALIMENTATION DISPONIBLE À L'INSTALLATION. SI LA FICHE DE BRANCHEMENT DOIT ÊTRE CHANGÉE, FAIRE APPEL À UN TECHNICIEN QUALIFIÉ QUI DEVRA SE RÉFÉRER AU TABLEAU CI-DESSOUS. LE FIL VERT/JAUNE DOIT ÊTRE BRANCHÉ DIRECTEMENT AU CHÂSSIS DE L'APPAREIL.

CONNECTEURS		COULEUR DU FIL	
		Normal	Alt
L	PHASE	MARRON	NOIR
N	NEUTRE	BLEU	BLANC
E	TERRE	VERT/JAU	VERT

ATTENTION : UN DÉFAUT DE MISE À LA TERRE PEUT PROVOQUER CERTAINS DYSFONCTIONNEMENTS DE L'APPAREIL OU DU SYSTÈME AUQUEL IL EST RELIÉ, POUVANT SE TRADUIRE PAR UNE TENSION COMPOSÉE ENTRE LA MASSE ET LA PRISE DE TERRE. CELA PEUT PROVOQUER DES BLESSURES SÉRIEUSES OU FATALES SI LA MASSE ET LA PRISE DE TERRE SONT TOUCHÉES EN MÊME TEMPS.

ATTENTION :

- APPARATET MÅ TILKOPLES JORDET STIKKONTAKT.
- APPARATEN SKALL ANSLUTAS TILL JORDAT UTTAG.
- LAITE ON LIITETTÄVÄ SUOJAKOSKETTIMILLA VARUSTETTUUN PISTORASIAAN.
- APPARATET SKAL TILSLUTTES JORDET STIKKONTAKT.

DÉCLARATION DE CONFORMITÉ

Nom du produit : dbx286S

Remarque : Nom du produit peut être suffixé par une combinaison des lettres de l'UE, M ou V.

Option du produit : Aucune

est conforme aux spécifications suivantes :

Sécurité : CEI/IEC 60065:2001 + Amd 1

CEM : EN 55022:2010 (s.o., produit analogique)
EN 55024:2010 + EN61000-3-2 + EN61000-3-3
Partie 15 des FCC (s.o., produit analogique)

Informations complémentaires :

Ce produit est conforme aux exigences suivantes :
Directive sur la basse tension 2014/35/UE
Directive 2014/30/UE
Directive RoHS 2011/65/UE
Directive DEEE 2012/19/UE

Contactez européenne :

Section 1 - Introduction1
1.1 Service Contact Info.....2
1.2 Warranty.....3

Section 2- Operating Controls.....4
2.1 Rear Panel4
2.2 Front Panel5

Section 3 - Basic Operation10
3.1 Connecting the 286s to Your System 10
3.2 Understanding the 286s Mic Preamp..... 10

Section 4 - Problems, Possible Causes, Solutions.....16

Section 5 - Technical Support and Factory Service.....18

Section 6 - Technical Specifications.....19

Section 7 - Block Diagram21

Section 1 - Introduction

Congratulations on choosing the dbx 286s Mic Preamp/Processor. The 286s is a powerful, user-friendly unit, providing concise and intuitive controls for all your mic processing needs, whether you use a microphone to record vocals and acoustic instruments, sample acoustic sounds, or for a public address system installation. The 286s is also capable of providing effective processing for electronic instruments, individual mixer tracks, and other mono sound sources.

You can think of the 286s as two separate processors, a Mic Preamp Section and a Processing Section. These two sections can be used together, or the 286s can be used as a dedicated Mic Preamp by defeating the Processing Section via the front panel BYPASS switch. Furthermore, the Processing Section provides four specific types of processing: Compression, De-essing, Enhancement and Expansion/Gating. These four controls can be used in any combination, as appropriate to your requirements. External audio processors (e.g., equalizer, delay unit, etc.), can be placed in the signal chain directly between the Mic Preamp Section and remaining 286s processing via the rear panel INSERT jack. We recommend that you take a moment and read through the 286s manual to better understand the power of the 286s processing, and how you can use the 286s to its fullest potential.

1.1 Service Contact Info

If you require technical support, contact dbx Customer Service. Be prepared to accurately describe the problem. Know the serial number of your unit - this is printed on a sticker attached to the bottom panel. If you have not already taken the time to fill out your warranty registration card and send it in, please do so now.

Before you return a product to the factory for service, we recommend you refer to the manual. Make sure you have correctly followed installation steps and operation procedures. If you are still unable to solve a problem, contact our Customer Service Department at (801) 568-7660 for consultation. If you need to return a product to the factory for service, you **MUST** first contact Customer Service to obtain a Return Authorization Number.

No returned products will be accepted at the factory without a Return Authorization Number.

Please refer to the Warranty information on the following page, which extends to the first end-user. After expiration of the warranty, a reasonable charge will be made for parts, labor, and packing if you choose to use the factory service facility. In all cases, you are responsible for transportation charges to the factory. dbx will pay return shipping if the unit is still under warranty.

Use the original packing material if it is available. Mark the package with the name of the shipper and with these words in red: DELICATE INSTRUMENT, FRAGILE! Insure the package properly. Ship prepaid, not collect. Do not ship parcel post.

1.2 Warranty

This warranty is valid only for the original purchaser and only in the United States.

1. The warranty registration card that accompanies this product must be mailed within 30 days after purchase date to validate this warranty. Proof-of-purchase is considered to be the burden of the consumer.
2. dbx warrants this product, when bought and used solely within the U.S., to be free from defects in materials and workmanship under normal use and service.
3. dbx liability under this warranty is limited to repairing or, at our discretion, replacing defective materials that show evidence of defect, provided the product is returned to dbx WITH RETURN AUTHORIZATION from the factory, where all parts and labor will be covered up to a period of two years. A Return Authorization number must first be obtained from dbx by telephone. The company shall not be liable for any consequential damage as a result of the product's use in any circuit or assembly.
4. dbx reserves the right to make changes in design or make additions to or improvements upon this product without incurring any obligation to install the same additions or improvements on products previously manufactured.
5. The foregoing is in lieu of all other warranties, expressed or implied, and dbx neither assumes nor authorizes any person to assume on its behalf any obligation or liability in connection with the sale of this product. In no event shall dbx or its dealers be liable for special or consequential damages or from any delay in the performance of this warranty due to causes beyond their control.

Section 2 - Operating Controls

2.1 Rear Panel

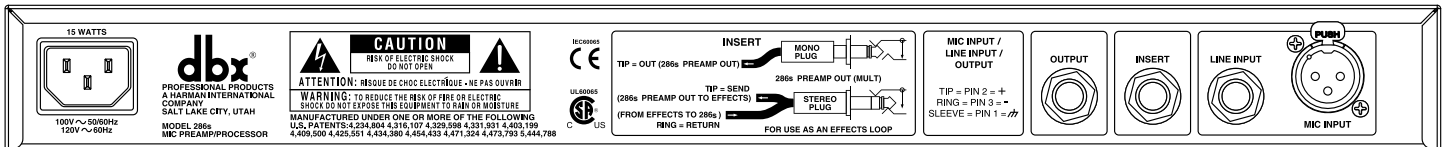

MIC INPUT Jack

The 286s MIC INPUT jack supports professional and home studio microphones by accepting either balanced or unbalanced signal through an XLR connector. Pins 2 and 3 are symmetrically balanced and floating; thus, either can be used as “HOT” without difficulty. Pin 2 is in phase with the TIP of all 1/4” connectors. Pin 1 is connected to the 286s chassis ground.

Note: Use a low impedance mic or a high-to-low impedance matching transformer with a high impedance mic.

LINE INPUT Jack

Use a 1/4” TRS phone plug to connect line level sources to the 286s (e.g., mixer outputs, effects loops, electronic keyboards, etc.). The 286s LINE INPUT jack accepts either balanced or unbalanced signals. Input impedance is 10k Ω unbalanced, 20k Ω balanced.

Note: In general, this jack does not support microphones with 1/4” plugs. Use an appropriate 1/4”-to-XLR adapter and plug the microphone into the MIC INPUT jack.

LINE OUTPUT Jack

The 286s LINE OUTPUT jack accepts either balanced or unbalanced 1/4” phone plugs. Nominal output signal levels is 0dBu into 600 Ω , and maximum output signal level is \gt +21dBu into 600 Ω . Output impedance is 100 Ω unbalanced, 200 Ω balanced. The output is tip HOT.

INSERT Jack

The 286s INSERT jack allows you to either add an effects loop directly into the 286s circuitry chain or take a separate mic preamp signal out.

To connect one or more external processors or effects devices (e.g., an equalizer, delay unit, etc.) between the Mic Preamp Section and the Processing Section, insert a 1/4” TRS plug carrying the external device’s output signal fully into the 286s INSERT jack; the TIP acts as a Send, carrying the signal from the Mic Preamp Section at an impedance of 100 Ω , while the RING acts as a Return for external devices to feed the 286s processing circuitry (i.e., 286s compressor, de-esser, etc.). This operation requires a Y-cable. When using INSERT as a direct-in to the Processing Section, MIC GAIN control, HIGHPASS button and PHANTOM POWER will not be active.

To use the INSERT jack to MULT the preamp out (i.e., to provide an output with a buffered version of the signal after the Mic Preamp circuitry, but before the Processing Section), insert a Mono 1/4" plug fully into the INSERT jack, then pull the plug out one click. Plug the other end of the cable to the appropriate load. This will still allow the original signal path to continue to the Processing Section without interruption.

Note: If the plug is accidentally pushed fully into the INSERT jack, it will break off the connection between the Mic Preamp and Processing Sections; in this case, there would be no signal at the 286s LINE OUTPUT jack.

AC Power

Connect the AC power cord to the AC receptacle on the back of the unit. Route the AC power cord to a convenient power outlet away from audio lines. The unit may be turned on and off from a master equipment power switch.

2.2 Front Panel

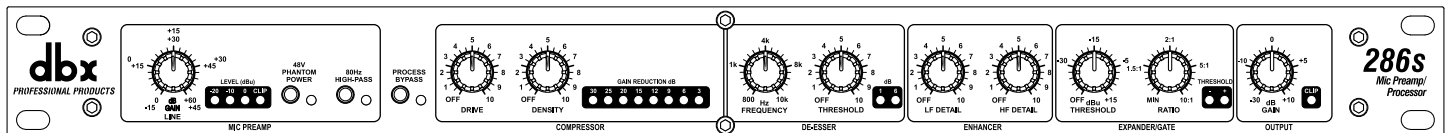

Note: To reduce the risk of damage to your system, set the MIC GAIN control fully counterclockwise and lower your playback monitor levels before you connect a microphone, power on the unit, or press the PHANTOM button. This will eliminate spikes and surges, acoustical feedback, loud pops, momentary hiss, or other unwanted sounds.

Mic Preamp

MIC GAIN (dB) and LEVEL (dBu) LEDs (including CLIP LED)

Use this control to set the level of gain added to the microphone input signal (or a line-level input). Note that the 286s processing controls, or an external processor connected to the 286s INSERT, can provide additional gain. Try to set the MIC GAIN control so that you do not have to reset it repeatedly; allow headroom for the maximum expected levels. For microphones (connected to the XLR MIC INPUT connector), the 286s can provide +0dB to +60dB of input gain. For line-level inputs (connected to the LINE INPUT jack), the gain is from -15dB to +45dB.

Note: To get the lowest noise possible from the 286s, set the input attenuators (if any) on your recorder or mixer for nominal levels (often about 3/4" of the way up or at the detent position; refer to the device's operating manual). Then, set the 286s MIC GAIN so that your recorder or mixer is at its optimal operating level.

The red CLIP LED (located to the left of the MIC GAIN control) indicates that the combination

of the mic signal and additional gain exceeds the circuit's capabilities; reduce gain via the MIC GAIN control. Set the MIC GAIN control so that the CLIP LED never lights.

The LEVEL LEDs can also be used to check the strength of the input signal. For example, the 286s does not support low level microphones plugged into its 1/4" INPUT jack; in this case, the LEVEL LEDs would not light, because the signal is too low.

PHANTOM POWER Button and LED

When you use phantom powered mics with your 286s, press the PHANTOM POWER button In to activate the 286s phantom power, providing +48VDC to the microphone through its connecting cable. This industry-standard configuration supports virtually all currently-manufactured phantom power mics. If you do encounter problems, it will typically be with an older mic. Note that some mics may take several seconds to fully power up when phantom power is applied. If you are using mics that do not require phantom power, press the button so that it is in the Out position.

Note: Always plug in a condenser mic with PHANTOM POWER Off and gain levels down. Then switch the PHANTOM POWER On and adjust the gain as needed.

The yellow PHANTOM POWER LED lights when the PHANTOM POWER button is in.

80 Hz HIGHPASS Button and LED

Press this button In to activate the 286s pre-processing third order filter. The HIGHPASS function filters out frequencies below 80Hz by 18dB/octave before any compression, de-essing, etc., is applied to input signal. This is most effective for reducing hum, rumble, wind and other low frequency problems. The HIGHPASS filter is also before any external processing provided via the rear panel INSERT jack.

The HIGHPASS LED lights when the HIGHPASS button is In.

Bypass

PROCESS BYPASS Button and LED

Press this button In to bypass the 286s Compressor, De-Esser, Enhancer, and Expander/Gate processing circuitry and the OUTPUT GAIN control (as well as any processing provided by external processors via the rear panel INSERT jack). In Bypass mode, the 286s will apply gain and filtering as set with Mic Preamp Section controls. BYPASS is equivalent to setting the Compressor DRIVE, De-Esser THRESHOLD, Enhancer LF and HF DETAIL and Expander/Gate THRESHOLD controls to OFF, the OUTPUT GAIN control to 0dB (12:00 position), and not connecting any external processing to the rear panel INSERT jack. Bypass is especially useful for making comparisons between processed and unprocessed signals.

The red PROCESS BYPASS LED lights when the PROCESS BYPASS button is pressed In.

Note: The Compressor is Off when the DRIVE is set to OFF.

Compressor

DRIVE Control

The DRIVE control determines the overall amount of gain reduction by setting the signal level going into the gain control circuitry. Turning DRIVE clockwise will increase the input signal, and therefore increase the amount of applied gain reduction. Turning DRIVE fully counterclockwise (to OFF) allows the compressor to pass all signals unattenuated, effectively bypassing the compressor.

Higher DRIVE settings can cause the Compressor Section to add substantial gain to signal, especially with low input levels. For example, setting the DRIVE control to 12:00 can add up to 20dB of gain to low signal levels. With hotter input levels going into the Compressor Section (whether from the MIC INPUT, LINE INPUT or INSERT jacks), gain addition due to the DRIVE control will be less noticeable.

DENSITY Control

Use this control to speed up or slow down the program-dependent release times. The scale is arbitrary because the release time is automatically varied according to the nature of the program material (to minimize audible compression-induced side effects). The release rate is from 0 (a slow release for smooth compression) to 10 (a fast release where compression follows the envelope of the program very tightly).

There is no absolute “right” way to set the DENSITY control. However, in general, slower settings are useful for gating out noise present behind vocals and acoustic instruments, while faster settings are useful for tightening up the sound of percussion instruments (e.g., a kick or snare drum).

GAIN REDUCTION (dB) Meter

This meter shows the true peak gain reduction in dB. If the red LED at the far left of the meter lights, no further gain reduction is available.

De-Esser

FREQUENCY Control

Use the control to set the HIGHPASS frequency of the variable filter used in the De-Esser circuitry. Settings between 4-8kHz will yield the best results for vocal processing, while more extreme settings allow the 286s to be used in other non-vocal applications.

THRESHOLD Control

Use this control to set the sensitivity of the De-Esser as a percentage of the average program level at the 286s input. This means that the De-Esser tracks the input level so the amount of de-essing remains constant with changes in input level.

The De-Esser 1dB and 6dB THRESHOLD LEDs light when the De-Esser is active. These indicate (in dB) how much sibilance reduction is occurring due to the De-Esser.

Enhancer

Note: The low and high frequency enhancers are off when their respective DETAIL controls are set to OFF.

LF DETAIL Control

The 286s Low Frequency enhancement simultaneously applies an 80Hz boost and 250Hz cut to the program. This lets you apply substantial bass boost without making the program sound muddy or boomy due to excessive mid-bass boost.

HF DETAIL Control

This control determines the amount of High Frequency spectral-enhanced signal added to the input signal. Spectral Enhancement is a form of dynamic phase and amplitude equalization. Continuous analysis of the input signal intelligently and automatically determines the amount of equalization necessary at each moment to achieve detailed, defined audio that is never shrill or over-sibilant.

Expander/Gate

Note: The Expander/Gate is off when the Expander/Gate THRESHOLD is set to OFF.

THRESHOLD (dB) Control and LEDs

Adjusting this control sets the level at which the expander/gate will fully open and allow the signal at the input to pass through to the output. Turning the knob fully counterclockwise (to OFF) allows the gate to pass all signals unattenuated, effectively bypassing the gate. Turning the knob fully clockwise causes the gate to attenuate input signals below approximately +15dBu. The amount of attenuation depends on the setting of the Expander/Gate's EXPANSION RATIO.

The THRESHOLD (-) LED (located to the right of the EXPANSION RATIO control) lights when the signal is below the set THRESHOLD. The THRESHOLD (+) LED lights when the signal is above the set THRESHOLD. The combination of these two LEDs also serves as the "POWER ON" function, as one or the other is always on.

EXPANSION RATIO Control

This control sets the amount of attenuation applied to the input signal once it is below the threshold, from gentle downward expansion (appropriate for mixed program, vocals, etc.), to a hard gating effect (effective for percussion). Fairly low EXPANSION RATIO settings (and higher Expander/Gate THRESHOLDS) work best for downward expansion, whereas higher EXPANSION RATIO settings (clockwise towards 10:1) work best for gating. If a setting produces undesirable "pumping" readjust the Expander/Gate EXPANSION RATIO and THRESHOLD settings.

Note: The attack and release rate of the Expander/Gate are program-dependent -- very fast for transient material (e.g., percussion) and slower for material with slow attack (e.g., vocals).

Readjust as needed to gate out noise -- external, as well as hiss from the unit. The 286s other processing can add substantial gain to a signal, especially at higher settings, thereby increasing the noise floor.

Output

GAIN (dB) Control and CLIP LED

The OUTPUT GAIN control sets the level at the line output. The OUTPUT GAIN control is especially useful to compensate for the RMS level changes which result from the 286s processing effects. For example, to decrease the overall gain (e.g., when the 286s processing has added too much gain), simply turn the OUTPUT GAIN control counterclockwise. The OUTPUT GAIN can also be used to counter any gain reduction after you have adjusted the 286s controls for the desired amount of processing; adjust the OUTPUT GAIN control clockwise, to add gain as needed.

The red OUTPUT GAIN LED (located to the right of the OUTPUT GAIN control) lights when the 286s Processing Section is clipping; reduce gain via the OUTPUT GAIN control. Set this control so that the OUTPUT CLIP LED never lights. If the OUTPUT CLIP LED is still lit, reduce the gain caused by the 286s processors (e.g., high Compressor DRIVE settings) or the gain provided by an external processor connected to the INSERT (if any).

If the meters on your load device (e.g., recorder, mixer, etc.) are in the red and your OUTPUT CLIP LED is not lit, simply reduce the 286s OUTPUT GAIN until the desired levels are obtained. If your load device is still in the red, reduce its input attenuators (if available).

Section 3 - Basic Operation

3.1 Connecting the 286s to Your System

The 286s can be used with any low-level microphone signal (via the MIC INPUT) or any line-level device (via the LINE INPUT). Some common line-level devices include: mixing consoles, electronic musical instruments, patch bays, and signal processors. For all connections, refer to the following steps:

1. Turn Off all equipment before making any connections.
2. Mount the 286s in a rack. (Optional)

Caution: Never remove the cover. There are no user-serviceable parts inside.

The 286s requires one rack space (height) and one rack space (width). It can be mounted above or below anything that doesn't generate excessive heat, since it requires no special ventilation. Ambient temperature should not exceed 113°F (45°C) when equipment is powered.

3. Make connections via rear panel jacks and connectors according to your requirements.
 - A. Connect a microphone to the MIC INPUT XLR connector or a line level source to the 1/4" LINE INPUT jack.
 - B. **Important:** DO NOT connect anything other than a microphone to the MIC INPUT.
 - C. Connect the load (e.g., mixer, recorder, etc.) to the 286s LINE OUTPUT jack.
 - D. Connect an external processor or effects device to the 1/4" INSERT jack. (Optional)
4. Connect the AC power cord to the AC power receptacle on the back of the unit.

Note: We recommend you always power on the unit with the MIC GAIN control set to its minimum level (fully counterclockwise). This will help in safeguarding your system against sudden spikes and surges, as well as possible acoustical feedback if a microphone is connected and left "open."

Note: Check the line voltage (printed on 286s) and verify that it is correct.

3.2 Understanding the 286s Mic Preamp

The 286s Mic Preamplification Section includes support for phantom-powered mics, a highpass filter, and an input gain control. Note that these controls are applied to the input signal before the signal is processed by the 286s Processing Section.

Phantom power is available at the push of a button, providing +48VDC to phantom-powered microphones. The 286s phantom power is sufficient for most microphones. However, some vintage condenser mics may require a separate power source.

Press the HIGHPASS button In to cut signals below 80Hz by 18dB/octave, effectively filtering out mic proximity effects, hum, rumble, wind and other low frequency “undesirables.”

Use the MIC GAIN control to achieve the best definition and character possible from your microphone. The 286s Mic Preamp delivers up to 60dB of sonically transparent gain to reveal the detail and audio signature of even the most esoteric mics. It transforms their low level output signal to a high level, high current signal that is internally fed to the 286s main processing chain (i.e., compressor, de-esser, etc.)

Using the 286s as a Dedicated Mic Preamp

To use the 286s as a dedicated mic preamp, simply press the BYPASS button to defeat the Processing Section circuitry. This allows you to use the Mic preamp’s PHANTOM POWER switch, HIGHPASS button and MIC GAIN control without routing the signal through any of the processing circuitry.

Processing Section

The 286s Processing Section consists of four specific processors: Compressor, De-esser, Enhancer, Expander/Gate. These four processors can be used in any combination or the 286s can be set as a dedicated single-function processor (refer to the following pages).

Compressor

A compressor is a device that changes its gain in response to the signal at its input. Many compressors have a user-selectable level, called THRESHOLD, to help determine when compression occurs. If the input signal is low in level (below the threshold of compression) the compressor gain remains fixed. If the input increases above the threshold of compression, the gain begins to decrease (i.e., the amount of gain reduction increases). For very large input signals, the gain can decrease considerably. On the 286s, compression occurs as an input level is “driven” into gain reduction by the DRIVE control; as the DRIVE setting (adjusted clockwise from OFF) increases input gain, the amount of gain reduction also increases. The 286s does not have a Threshold control; the threshold is established by the setting of the DRIVE control.

Use the Drive control to set the amount of gain reduction (i.e., how much the input signal is being compressed). Use the DENSITY control to set the compressor’s release time (i.e., how fast the compression circuit returns the input to its original level).

The 286s patented and versatile Compressor can smoothly and unobtrusively ride gain, and assertively increase punch and density. The 286s achieves its outstandingly transparent audio performance by finely-tuned control circuitry that eliminates the dynamic distortions present in most conventional compressors and limiters. The use of a quiet, low-distortion dbx VCA ensures negligible static distortion and noise. Compression is especially useful for smoothing out a vocal performance, raising a signal out of a mix, fattening kick or snare drums, or adding sustain to instruments (such as an acoustic guitar or bass).

De-Esser

A De-Esser is a device that reduces the high frequency energy present in certain vocalizations, of which the most common is sibilance. Sibilance is the hissing or rushing sound produced

by blowing air through a constricted (narrow) mouth opening or across the edge of the teeth, as in the “s” and “sh” in “sash.” Sibilants contain predominantly high frequency components with a sharp rise above 1kHz and most of the energy in the 4kHz to 10kHz band, centered on 6kHz to 8kHz.

Adjust the De-Esser’s frequency control to set the frequency above which the 286s responds to audio containing sibilants. The 286s detects sibilant material by comparing the high-frequency energy of an audio signal to the full bandwidth energy of that signal. When the high-frequency energy is excessive relative to the full bandwidth energy, the 286s quickly reduces the gain, or “de-esses.” The frequency control sets the high-pass filter frequency of the high-frequency level detector. For normal vocal de-essing, the frequency should be set between 4-8kHz. Further adjustment of the frequency control enables the 286s to be used for processing instrumental material, such as removing “clicks” from a close mic’d piano or acoustic guitar.

Adjust the De-Esser’s THRESHOLD control to quickly reduce any sibilance (i.e., excessive vocal sounds like “sss”), high-frequency overload distortion (e.g., a cymbal crash that can overload tape, drive amps into distortion and fatigue listeners), or even guitar string slide noise.

We recommend the 286s De-Esser for use almost exclusively on single voices or instruments for sibilance. The De-Esser should not be used on mixed program material.

Enhancer

An Enhancer (sometimes called a Spectral Enhancer) adds clarity and detail to vocals or other line level signals by “intelligently” boosting specific frequency ranges.

Use the HF DETAIL control to add high frequency energy to the input signal. Use the LF DETAIL to add punch and definition at the lower end of the spectrum.

The HF Detail circuitry in the 286s uses a dynamic shelving equalizer to provide results superior to even complex equalization. In many situations, the amount of high frequency content in the material you are working with will vary. Typical equalization schemes will produce results which are right some of the time, and completely wrong at other times. But not with the 286s. The equalizer’s dynamic operation and sliding corner frequency ensure that high frequency enhancement is applied only when needed and in the specific frequency range necessary to maintain proper spectral balance moment to moment. HF detail is perfect for adding definition to muddy vocals, guitar or horn tracks. It can also add “zing” and crispness to percussion tracks - acoustic or sampled.

As you increase the amount of LF Detail, the circuitry boosts lower bass frequencies while simultaneously cutting problem frequencies in the upper bass/low midrange region which often makes program material muddy. Use LF Detail to create a “big,” chesty, male voice or to add fullness and power to lower frequency percussives (e.g., kick, toms, timpani).

Expander/Gate

A Gate is essentially a device that controls the level of an input signal by “opening” and “closing.” A user-selected level, called THRESHOLD, helps determine when the gate opens and closes. If the input signal is above the threshold, the gate is “open,” allowing the signal

to pass. If the input signal is below the threshold, the gate “closes” and the input signal is attenuated. With sufficient attenuation, it effectively cuts that signal off. On the 286s, the amount of attenuation is set with the EXPANSION RATIO control.

The 286s gate provides more flexibility than traditional switch gates because it actually functions as a combination gate/expander. Where switch gates are generally only suitable for a limited number of uses (e.g., gating percussion), the gate on the 286s acts as a gentle downward expander at low EXPANSION RATIO settings (suitable for vocals, guitar, etc.) and can effectively work as a switch gate when used at high EXPANSION RATIO settings.

When an input signal exceeds the user-selected THRESHOLD, signals pass unaffected. However, when part of a signal is below THRESHOLD, that part is downward expanded. (This differs from gating in that the attenuation effect of downward expansion is gentle.) Downward expansion works well with program material that has a less defined attack and release. Use downward expansion with voice - as opposed to percussive sounds which have a quick, defined attack and release.

Adjust the Expander/Gate THRESHOLD and EXPANSION RATIO controls to prevent headphone leakage or to cut the background noise when gain is added at all the preceding stages of the 286s.

Using the Four Processors in Different Combinations

Note: Too high of a THRESHOLD setting with expansion (i.e., lower EXPANSION RATIOS), may cause the 286s to attenuate the desired portion of the signal, as well as the undesired portion. Too high of an EXPANSION RATIO setting may cause undesirable effects with highly modulated program material like vocals.

Note: The following example is provided as a guide to highlight how the 286s front panel controls can be used simultaneously for multiple purposes. Suggested settings are specific to this example. Once you have connected the 286s to your system (see page 10), adjust the 286s controls as required to support your setup and to achieve your desired results (refer to Suggested Settings/Usages, below).

An Example: You are using a condenser microphone to record a vocalist whose “sss” sounds sting while the overall character of the vocal part is rather dull and the vocalist is constantly changing his/her distance from the microphone, and your studio is complete with hum from bad cabling, and noise from heavy construction work nearby. The 286s can be used to rectify each of these problems and also provide additional processing to highlight the best qualities of the vocal performance.

Press the PHANTOM POWER button in to support the phantom power mic (after reducing playback gain).

Press the HIGHPASS button in to reduce the hum.

Adjust the Compressor DRIVE and DENSITY controls to smooth out the vocal performance. To

slow the compressor's release time, set the DENSITY control to 0.

Set the De-Esser frequency control to 4kHz (12:00 position).

Adjust the De-Esser THRESHOLD control to reduce the vocalist's sibilance.

Use the HF DETAIL, to taste, to add life to the vocal. Defeat the LF DETAIL by setting it to OFF.

Set the Expander/Gate THRESHOLD and EXPANSION RATIO controls starting with a setting of around 11:00. Adjust these controls so that background noises are gated out when the vocal part is low or not present.

Because minimal processing levels often produce the best results, the 286s processing should initially be applied conservatively (to taste); avoid overusing an effect, unless it is absolutely necessary. (For example, use De-Essing for sibilance or high frequency distortion only; otherwise, turn the control OFF. Or, for material already rich in high frequencies, set the HF DETAIL to Off, or use it minimally.) This will ensure that the 286s circuitry produces superior audio without any artifacts.

Suggested Settings/Usages

Expander/Gate

Note: The Expander/Gate is OFF when the Expander/Gate THRESHOLD is set to the "off" position.

Suggested Initial Gate settings:

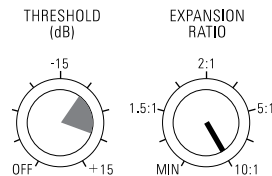

Gating Dry Percussive Sounds (i.e.: Snare Drum, Kick Drum)

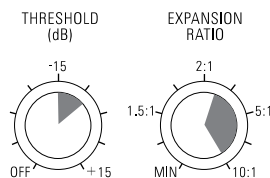

Gating Hum or Buzz from Live Instruments or Recorded Tracks

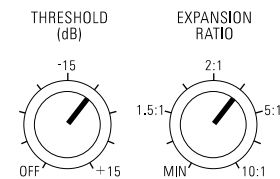

Gating Sounds that have Longer Decay (i.e.: Cymbal, Piano)

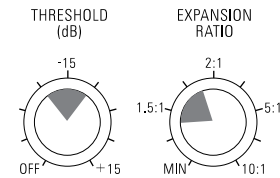

Downward Expansion to Reduce Noise Under Smooth Sounds (i.e.: Vocals, Woodwinds)

Enhancer

Note: The High and Low Frequency Enhancers are OFF when their respective DETAIL controls are set to the "off" position.

Suggested Usage:

	Female Voice	Male Voice	Keyboard	Guitar	Bass Guitar	Drums	Strings/Horns	Club Sound/DJ
LF Detail	--	◇	◇	◇	⊠	◇	◇	⊠
HG Detail	⊠	⊠	◇	⊠	◇	◇	⊠	⊠

- ⊠ Recommended; These sound sources can be effectively re-energized and enhanced with treatment. Use to taste.
- ◇ Program-Dependent; Use when program material needs treatment. Make sure you use only as much treatment as needed.
- Not Recommended. The 286s is generally not applicable to these applications.

Compressor

Note: The Compressor is OFF when the Compressor DRIVE is set to the "off" position.

Suggested Initial Compressor settings:

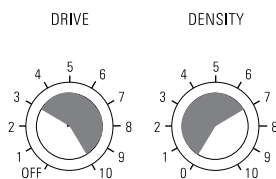

Smoothing Out A Vocal Performance

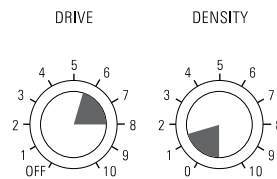

Raising a Signal Out of a Mix

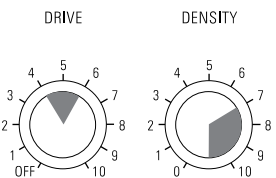

Fattening a Kick Drum or Snare Drum

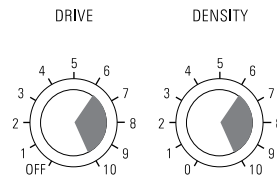

Adding Sustain to Guitar or Synthesizer String Sounds

Section 4 - Problems, Possible Causes, Solutions

Always verify that the problem is not in the source material being fed into the 286s, or in the other parts of the system. If you still have problems when using the 286s, consider the following remedies.

Noise Rushups, Hiss Buildup

Higher DRIVE settings on the compressor often add gain to the signal. If the signal already has substantial hiss, the compression can actually increase the hiss. As a compressor releases and the gain of the input signal increases, background noise and hiss can increase. This is called noise rushup. Remedy this by using compression conservatively. Also, to reduce noise rushups, especially during pauses, lower the Compressor DENSITY setting. For both cases, set the Expander/Gate to match the compressor's release time, thereby gating out the noise or hiss as much as possible without truncating the signal.

Increased hiss can also result from high frequency "detailing." The HF DETAIL enhancer estimates how much high frequency boost is appropriate for a given input signal. If the signal is dull but noisy (e.g., vocals recorded to a bad cassette), the HF DETAIL will make it brighter and can pull up hiss to objectionable levels. (The hiss will often be audibly modulated by the material because the HF DETAIL is adaptive to the material.) Reduce the setting of the HF DETAIL control until the effect is no longer objectionable.

For multitrack studio applications, consider gating out the hiss during the initial recording, then adding HF DETAIL enhancement afterwards, during mixdown.

Audible Distortion

With certain combinations of controls, especially when they are used at more extreme settings (towards fully clockwise), distortion or artifacts may occur. In this case, lessen one or more of the controls in use. For example, higher DRIVE settings on the compressor often add gain to low-level signal, especially when used in conjunction with other controls. To reduce distortion, simply reduce the compression setting. If you still want more compression, return the compression to its previous setting, and reduce one or more of the other controls which commonly increase gain (e.g., Enhancer DETAIL controls, MIC GAIN, etc.).

Setting the DENSITY control higher than the 12:00 position can sometimes cause audible distortion in the bass because the very fast release time begins to modulate each individual cycle of the bass waveform. If this occurs, turn down the DENSITY control. (Patented circuitry in the 286s greatly reduces this effect when compared to many other compressors operated at equally fast release times).

Sound Cutting Off

Higher Expander/Gate settings can cut off sounds prematurely, specifically after a sudden transient or loud note has decayed. This could result in unintelligible vocals, incomplete chords, inferior cymbal splashes, lost reverb tails, etc. To retain the complete input signal, but still maintain required expansion and gating (e.g., to reduce settings until the complete

signal is adequately restored). This means that you should set the Expander/Gate controls so that the red (-) THRESHOLD LED (located to the right of the EXPANSION RATIO control) does not light until the required signal is finished.

Lispy Vocals

With higher settings of the De-Esser THRESHOLD or Expander/Gate THRESHOLD controls, a vocal performance can be marred by resultant lisps (i.e., where s and z sounds are heard as th sounds). Lisps can usually be corrected by reducing the De-Esser THRESHOLD, or the Expander/Gate THRESHOLD, or both.

Shrillness or Excessive Brightness

If high frequency energy in the audio is producing shrillness or excessive brightness, try reducing the HF DETAIL or increasing the De-Esser THRESHOLD (if the audio is a single track), as appropriate.

Low Rumble or Excessive Low Frequencies

Although the HIGHPASS button works effectively to reduce hum, rumble, wind noise, etc., at the input, LF DETAIL can restore low frequency power to objectionable levels if used too liberally. This is especially true if the rear panel INSERT is used; this places a unit (e.g., an equalizer) directly between the Mic Preamp Section and Processing Section of the 286s - hum or other undesirable low frequencies "inserted" by the device cannot be corrected by the HIGHPASS button. In most cases, make sure the LF DETAIL is used conservatively.

No Gain Reduction Shown When Compression is DRIVE Control is Active

Increase MIC GAIN or Compressor DRIVE.

Section 5 - Technical Support and Factory Service

The 286s is an all-solid-state product with components chosen for high performance and excellent reliability. Each 286s is tested and calibrated at the factory and should require no internal adjustment of any type throughout the life of the unit. We recommend that your 286s be returned to the factory only after referring to the manual and consulting with Customer Service.

Our phone number, fax number and address are listed on the back cover of this manual. When you contact dbx Customer Service, be prepared to accurately describe the problem. Know the serial number of your unit -- this is printed on a sticker attached to the rear panel.

Note: Please refer to the terms of your Limited Two-Year Standard Warranty, which extends to the first end-user. After expiration of the warranty, a reasonable charge will be made for parts, labor, and packing if you choose to use the factory service facility. In all cases, you are responsible for transportation charges to the factory. dbx will pay return shipping if the unit still under warranty.

Shipping Instructions: Use the original packing material if it is available. Mark the package with the name of the shipper, and with these words in red: DELICATE INSTRUMENT, FRAGILE! Insure the package properly. Ship prepaid, not collect. Do not ship parcel post.

MIC INPUT	Floating balanced, Pin 2 Hot
Impedance	~ 4.2k Ω Balanced
Maximum Level	0.25Vrms, Gain=30dB
Gain Adjustment Range	+0dB ... +60dB
Phantom Power	+48VDC, applied to XLR pins 2 and 3 through 6.81k Ω resistors
CMRR	>40dB, typically 55dB
EIN	-125dBu, 22Hz-22kHz, 150 Ω source impedance
LINE INPUT	Floating balanced, TIP Hot
Impedance	10k Ω unbalanced, 20k Ω balanced
Maximum Level	>+21dBu, balanced or unbalanced
Gain Adjustment Range	-15dB ... +45 dB
CMRR	>40dB, typically 55dB
INSERT (1/4" TRS phone)	Normalled; tip is Send, ring is Return
Ring: Impedance	>5k Ω
Maximum Level	>+21dBu
Tip: Impedance	100 Ω
Maximum Level	>+21dBu, >+20dBm (600 Ω load)
Noise	<-89dBu, unweighted (20Hz-20kHz); LINE GAIN Control set to 0dB
Distortion	<0.01% THD, 20Hz-20kHz, +10dBu
LINE OUTPUT (4" TRS phone)	Balanced/Unbalanced
Impedance	100 Ω unbalanced, 200 Ω balanced
Maximum Level	>+21dBu, >+20dBm (600 Ω load)
Gain Adjustment Range	-30dB ... +10dB
Noise	<-85dBu unweighted (20Hz-20kHz); Both Gain Controls set for 0dB, all processing controls OFF
Frequency Response	20Hz ... 20kHz, +0.5, -0.5dB
Distortion	<0.08%THD, 20Hz-20kHz, +10dBu, all Processing Controls OFF
COMPRESSOR	
Threshold Range	-40dBu to +20dBu
Compression Ratio	>4:1 For input levels beyond 20dB above threshold
Maximum Compression	30dB
Attack Time	Program-Dependent; >1s for small level increases, down to 10ms for large increases
Release Time	Program-Dependent; adjustable between approximately 1dB/Sec and 75dB/Sec
Distortion	Typically <0.05%THD, 20Hz-20kHz, 15dB G/R, +10dBu Output, DENSITY @ 0
SMPTE Intermodulation Distortion	<0.05%; 60Hz/7kHz 4:1, 15dB G/R, +10dBu Output Level, DENSITY @ 0
DE-ESSER	
Characteristic	Wideband Gain Reduction
Frequency Range	800Hz to 10kHz High Pass, 12dB/octave
Release Time	Program-Dependent; approximately 1ms/dB

ENHANCER	
HF Detail Characteristic	Program-controlled shelving equalizer, approximately 15dB maximum HF boost
LF detail Characteristic	Bell-shaped boost @ 80Hz, bell-shaped cut @250Hz, ratio is approximately 2:1
EXPANDER/GATE	
Threshold Range	OFF ... +15dBu
Expansion Ratio	Adjustable 1.5:1 ... 10:1
Maximum Depth	>50dB
Attack Time	Program-Dependent, approximately 2ms (at maximum attenuation)
Release Time	Program-Dependent, approximately 10ms/dB
DYNAMIC RANGE	Typically 105dB
Power Requirements	15 W
Operating Voltage	JA/US Model: 100-120VAC, 50/60Hz EU/AU Model: 220-240VAC, 50/60Hz
Operating Temperature	32°F to 113°F 0°C to 45°C
Dimensions	1.75" x 5.75" x 19" 45 x 175 x 485 mm
Weight	Net Weight: 4.5 lbs; Shipping Weight: 6.5 lbs 2.04/2.95 kg

Note: 0dBu = 0.775Vrms

Specifications subject to change without notice.

Section 7 - Block Diagram

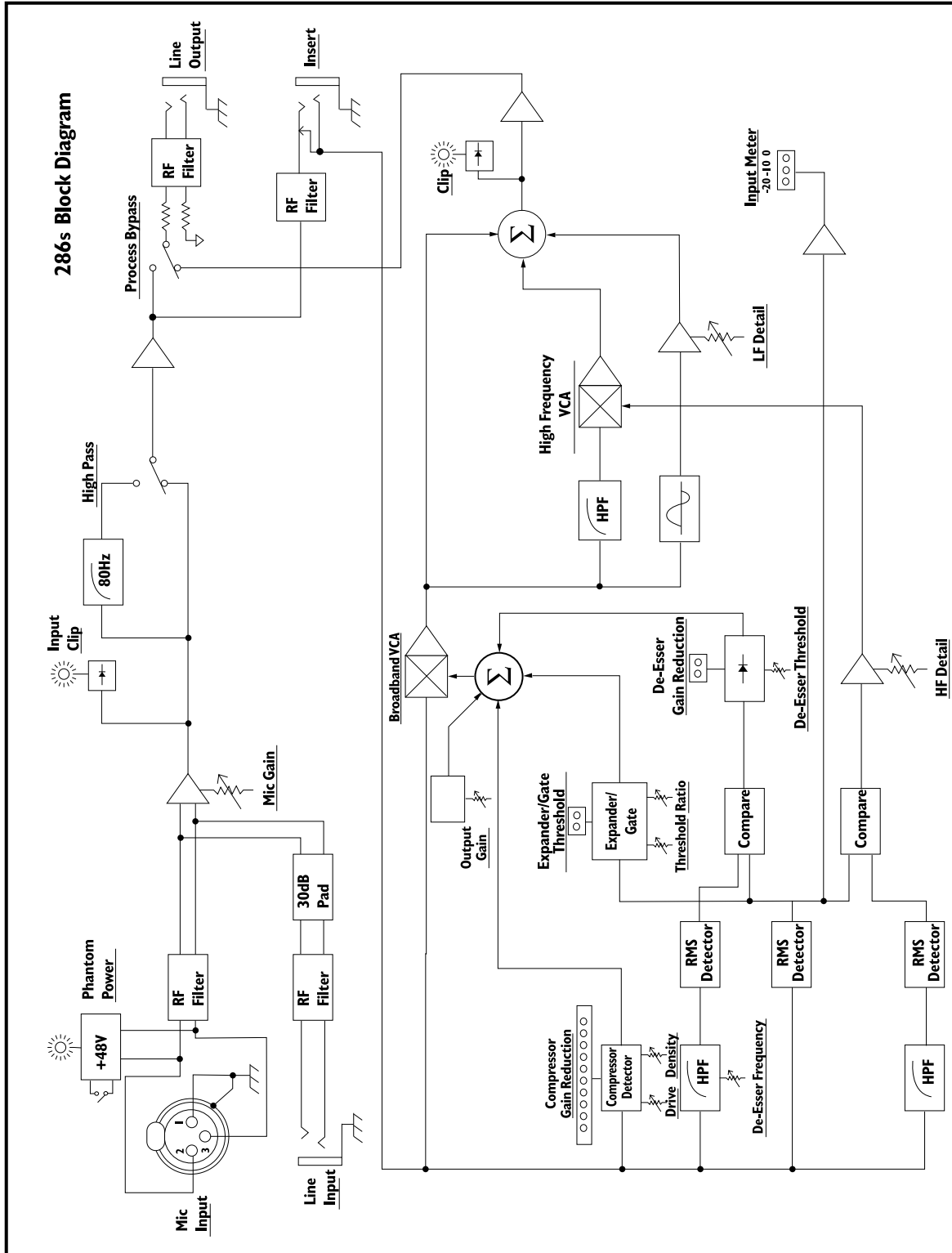



286s User Manual

PN: 18-0728V-B

Printed in China

dbx Professional Products is a registered trademark of HARMAN

© 2015 HARMAN

All rights reserved