



Active Loudspeakers  
**DXR Series**  
DXR8 DXR10 DXR12 DXR15

Active Subwoofers  
**DXS Series**  
DXS12 DXS15

Active Loudspeakers  
**DSR Series**  
DSR112 DSR115 DSR215 DSR118W



 **YAMAHA**  
YAMAHA CORPORATION  
P.O. BOX1, Hamamatsu Japan

\*Specifications and appearance are subject to change without notice. \*All trademarks and registered trademarks are property of their respective owners.



Printed in Japan

# Don't Hold Anything Back

At Yamaha, we understand that when inspiration hits, you can't have anything holding you back, and with DSR, DXR and DXS Series speakers powering your performances, nothing's going to come between you and your audience. Drawing from our decades of experience as one of the true innovative forces in the industry, we used every resource at our disposal at each stage of these speakers' development. Each series combines extremely powerful Class-D amplifiers with Yamaha's cutting-edge acoustic, structural and signal processing technologies, delivering the highest output levels in their class with stunning clarity and reliability. Whether used for front-of-house, rigged or floor monitoring applications, every detail of their versatile design is geared towards consistent performance for extreme durations at maximum output. Night after night you can depend on DSR, DXR, and DXS Series speakers to capture the full dynamic range of your expression— from subtle nuance to explosive energy— no matter how hard you drive them.

Cutting-edge Technology. Unrivalled Versatility. Unequalled Power— with the DSR, DXR and DXS Series speakers we didn't hold anything back.

So why should you?



Active Loudspeakers  
**DXR Series**



Active Subwoofers  
**DXS Series**



Active Loudspeakers  
**DSR Series**

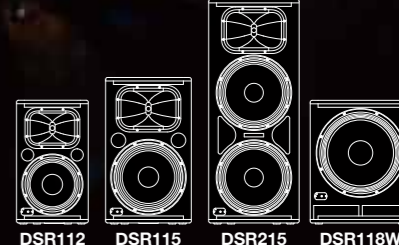

# Touring Intelligence in Portable Loudspeakers

Ever since we first started developing professional audio equipment in the 1960's, we've made it our goal to stay at the forefront of the technology curve. Drawing on decades of experience as a true industry innovator, we don't merely utilize cutting-edge technologies—we create them. With the express purpose of making the most powerful and reliable high-resolution speakers possible, we assembled a specialized team of Yamaha's most skilled engineers to examine, and improve on, every detail of loudspeaker design.

This passion for innovation served as the impetus for an intensive collaboration with loudspeaker giant NEXO, adding their insight and expertise as an industry leader in touring-grade sound reinforcement to the development of our DSR, DXR and DXS Series speakers. As a result of working closely with NEXO's engineers at their state-of-the-art facility, our team adopted a new approach to several crucial aspects of these speakers' design. The detailed analysis of the transducers, thorough testing of the enclosures' acoustic properties and optimized limiter setting all contributed to higher SPL delivered with stunning clarity and an unsurpassed level of reliability.

By incorporating touring-grade technology into these speakers, we've succeeded in creating the most powerful and dependable high-performance, active loudspeakers...ever.



## High Definition Sound

Our transducers, power amplifiers, enclosures and precise, detailed management of signal processing all contribute to produce our stunning high-definition sound. Utilizing our proprietary 48bit Digital Signal Processing, fully customized, premium-grade transducers and extremely accurate constant directivity horn, each full-range model is designed to ensure that the entire audience enjoys the same crystal-clear highs, throbbing bass and focused mids.

## Ultimate Power

Yamaha's next-generation high-efficiency Class-D power amplifiers deliver extremely high output levels, with very low distortion and incredibly natural sound from their compact and lightweight modules. Combined with rugged, non-resonant enclosures, custom designed high power handling transducers and formidable DSP, each speaker delivers class-leading SPL while retaining all the precise dynamics and clarity of the original sound.

## Outstanding Reliability

Yamaha's mastery of DSP utilization extends beyond sonic control, offering total management of the ongoing signal inside the system. Tour-proven, fail-safe protection functions ensure that the power supply, power amplifier and transducers all perform at their maximum potential even after extended durations of usage in the most severe conditions. Housed in sturdy, road-tested enclosures with heavy-duty steel grilles, each speaker promises enduring reliability you can count on.

## Unrivaled Versatility

Our durable, lightweight enclosures weren't designed just to look great; their versatile, compact design offers superior functionality in front-of-house, floor monitoring and installed applications. Every aspect of their physical design, from dimensions and shape, to rigging options and the accessibility of components attached to the enclosure, allows them to adapt seamlessly to countless sound reinforcement applications.



# The Power of "D"

Our development team took full advantage of a number of advanced digital technologies, both new and refined, based on Yamaha's extensive experience accumulated over many long years of developing professional audio equipment. Everything from the detailed management of crossover, EQ and time alignment to the limiter settings, protection functions and precise dynamic control of the sound, was subjected to endless simulation, in-house and field testing to ensure that these speakers produce the highest level of sound quality at the highest output levels possible. Combined with Yamaha's advanced analog signal processing and acoustic technologies, the "Power of "D" delivers ultimate performance.

## Ultra-Precise 48Bit DSP Processing for High Definition Sound

All full-range models feature Yamaha's proprietary FIR-X tuning™ utilizing linear phase FIR\* filters for the crossover. FIR-X tuning™ simultaneously optimizes frequency and phase response while adjusting the time alignment between the HF and LF transducers. This creates a very smooth response around the crossover point, providing much better clarity and imaging than what is possible with conventional crossovers.

All signals are precisely processed by a 48bit (76bit accumulator) high-performance processor for high-definition sound quality. All full-range models and DXS subwoofers employ high-precision 24bit discrete A/D and D/A converters with superior S/N ratio and dynamic range.

\*Finite impulse response

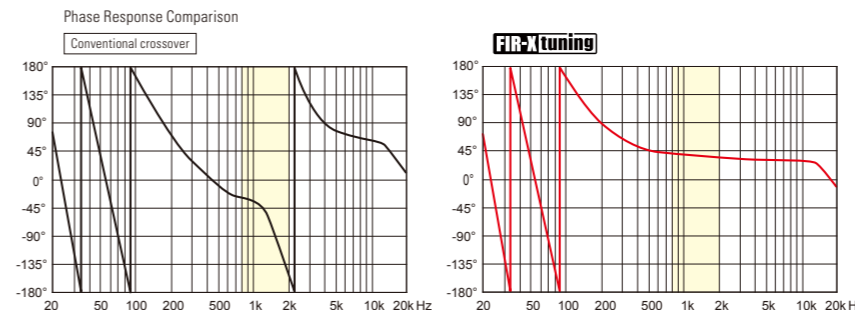

## Intelligent Dynamic Control for Consistent Clarity at Any Output Level

D-CONTOUR is an intelligent multi-band compressor that gives you powerful and consistent sound throughout all output levels. By constantly monitoring the output of multiple frequency bands and calculating the optimum EQ adjustments for each, even at maximum SPL levels, the DXR Series maintains outstanding clarity and musicality.

With the DXR Series, D-CONTOUR provides a more detailed tuning of your sound with two different settings: FOH / MAIN mode or MONITOR mode. FOH/MAIN mode boosts low-frequency to compensate for low-end that is typically missing when speakers are used in suspended applications or mounted on a speaker stand. MONITOR mode is completely optimized for floor monitor application by intelligently taming down the low-frequency that builds up due to floor reflection, smoothing out a wide range of frequency bands to give you stunning clarity for monitoring your sound. Both of these presets were perfected by performing countless listening tests with skilled sound engineers, giving you a multi-band compressor that performs dynamically, delivering consistent sound with minimal distortion at any output level.

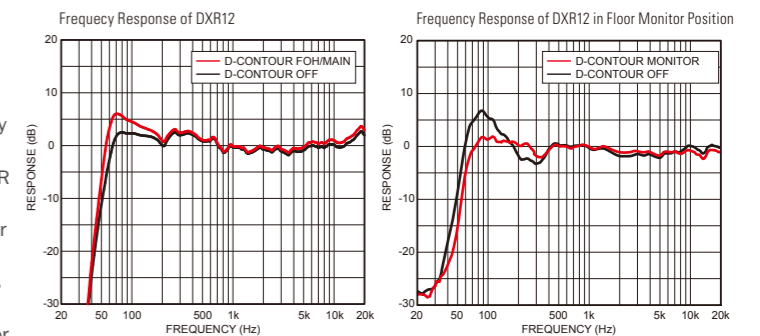

## Extensive DSP Protection Functions for Maximum Output

In a typical system comprising passive loudspeakers, power amps and signal processors, trying to set optimal parameters for each component can be a daunting task. One of the advantages of active loudspeakers is that the combination of transducers and amps can be perfectly optimized. During the development of the DSR, DXR and DXS Series, we measured and tested the durability of each transducer and the overall amp output through countless indoor and outdoor listening tests. Based on the test results, we were able to set the optimal limiter point for each model using precise DSP control. In addition to the optimal limiting, DSR, DXR and DXS speakers employ many of the same protection functions used in our top-class TXn Series professional power amplifiers. A microprocessor and high-power DSP monitor the status of the power supply, power amplifiers, transducers and ongoing signals to protect all aspects of each component. As a result, these speakers can perform to their full potential while ensuring reliable operation in even the most severe conditions.

\*The DSR118W is protected by an analog circuit.

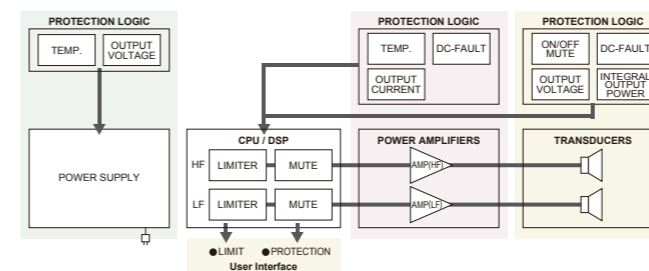

### Switchable White Front LED

Each of the DSR, DXR full-range speakers and DXS subwoofers has a white LED behind the front grille that illuminates when powered and varies in brightness depending on the amount of system limiting.



Active Loudspeakers  
**DXR Series**

DXR8 DXR10 DXR12 DXR15

Active Subwoofers  
**DXS Series**

DXS12 DXS15



## POWER TO THE PEOPLE

Performance runs in the family, and like the acclaimed DSR Series before it, DXR Series loudspeakers offer superb high-definition sound and class-leading sound pressure levels—yet in a more compact and extremely functional design that provides a level of versatility unmatched by any speaker in its class today. The DXR Series is comprised of four full-range models perfectly suited for front-of-house sound, monitors, simple amplification, rigged applications and more. Combining the series with our newly designed DXS subwoofers will further elevate your system's performance, giving you versatile control of its thunderous bottom end. With the perfect balance of raw power and innovative speaker technologies, you can depend on DXR Series speakers to deliver the full power of your performance to every member of your audience.

	Power Rating <sup>*1</sup>	Maximum SPL <sup>*2</sup>	Frequency Range	LF	HF	Coverage Angle
DXR8	1100W	129dB SPL	57Hz–20kHz	8" cone	1.4" diaphragm, 1" throat	H90°x V60°
DXR10	1100W	131dB SPL	56Hz–20kHz	10" cone	1.4" diaphragm, 1" throat	H90°x V60°
DXR12	1100W	132dB SPL	52Hz–20kHz	12" cone	1.4" diaphragm, 1" throat	H90°x V60°
DXR15	1100W	133dB SPL	49Hz–20kHz	15" cone	1.4" diaphragm, 1" throat	H90°x V60°
DXS12	950W	131dB SPL	47Hz–160Hz	12" cone	-	-
DXS15	950W	132dB SPL	45Hz–160Hz	15" cone	-	-

\*1 Dynamic Power \*2 Measured Maximum SPL (peak)

## High-Efficiency 1100W Class-D Amplifiers

### All-New Compact, High-Power DXR Amp Modules

All DXR Series loudspeakers are equipped with highly efficient Class-D amplifiers that were optimally designed to match the DXR's HF and LF transducers. These high-performance amplifiers deliver the highest sound output in their class with 1100W of power, producing an impressive SPL of up to 133dB. They also provide very fast attack and superior transient response, which greatly contribute to DXR Series incredible audio performance.

### Universal Switching-Mode Power Supply

The DXR Series employs an all-new, high-efficiency switching-mode power supply for its outstanding performance. The power supply is also suitable for use worldwide with its multi-voltage design.

## Intelligent Onboard 3-Channel Mixer

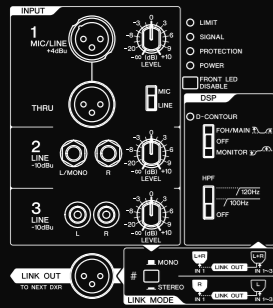

The DXR Series features a flexible onboard mixer with a variety of inputs, making it ideal for simple vocal/ instrument amplification. With its flexible IN/OUT connectivity, the DXR Series can comprise a full sound reinforcement system, or seamlessly integrate into a setup utilizing DSR or DXS Series speakers.

### Versatile Mic and Line Level Input Capability

The DXR onboard mixer can handle up to three simultaneous inputs. It accepts both Mic and Line level input, giving you the flexibility to connect to a variety of sources from microphones to line level instruments and portable audio devices. When in MIC position, a HPF is automatically activated to roll off unwanted low frequency.

### Flexible HPF Control

All DXR loudspeakers feature flexible HPF control to perfectly match with DSR and DXS subwoofers. You can choose either 100Hz or 120Hz depending on which subwoofer you are using in combination with the DXR. DXS Series subwoofers feature flexible LPF settings allowing you to find the optimal HPF/LPF balance for your sound.

## Superior Components. Unequaled Performance.

### Custom-Designed DXR Transducers

All DXR Series transducers were meticulously selected and thoroughly customized to deliver ultimate performance. The detailed characteristics and behaviour of each transducer was fully analyzed and evaluated with sophisticated computer simulations in order to help realize their full performance potential. The high power output woofers deliver minimal distortion and defined, deep bass, while the 1.4" precision compression drivers produce accurate midrange and high frequencies up to 20 kHz.



### Smart Mixing / Linking Function

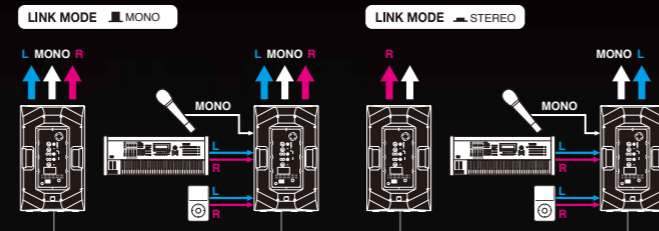

Each channel has an individual volume control, letting you mix three discrete audio sources. THRU out passes the input signal from Channel 1 and LINK OUT sends mixed signal from all channels—ideal for daisy-chaining or routing the signal to another destination. LINK OUT is very useful for configuring a compact SR system with another DXR, while LINK MODE allows you to easily switch between stereo or dual-mono configurations.

### DXR Wide Dispersion Constant Directivity Horn

The HF transducer is mounted to an all-new 90°x 60° constant directivity horn, designed with the goal of minimizing radiation pattern deterioration in oblique directions as more conventional horns are prone to doing. This can help to achieve a more ideal coverage area without irregularities. With the new wide dispersion constant-directivity horn, sound expands in a more rectangular pattern providing 90° horizontal x 60° vertical coverage, with wide-frequency sound projected to the edges of the coverage area.

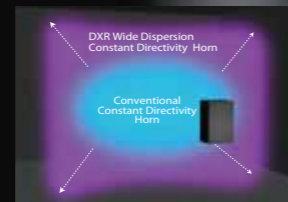

## Rugged. Versatile. Functional.

The durable, portable design of its enclosure makes the DXR Series perfectly suited for use in a variety of environments including front-of-house sound, rigged applications, floor-monitoring and more.

### Durable, Compact ABS Enclosures

Full-range models are moulded in rugged, non-resonant ABS enclosures and are designed to dampen down vibrations caused by high output levels, producing less distortion and superior sonic quality. The road-tested enclosures are equipped with heavy-duty steel grilles and ergonomic, gripped aluminum handles that greatly improve durability and portability.



### Rigging Points for Standard Eye-Bolts and Optional U-Brackets

DXR Series loudspeakers come equipped with rigging points, allowing for rigged application with standard eyebolts\*. When more versatility is required, optional U-brackets allow simple and easy rigging in both horizontal and vertical configurations.

\*Eyebolts not included

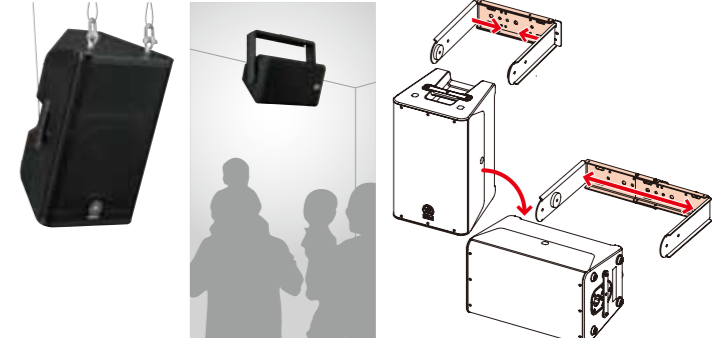

### Symmetrical Enclosure Design for Mirror-Mode Floor Monitoring

The DXR12 and DXR15's enclosure design enables mirror-mode monitor placement that creates a symmetrical sound field for the performer with a larger, more defined "sweet spot". Used in either a balanced dual-mono configuration or a stereo monitor mix setup, mirror-mode floor monitoring can enhance your performance considerably.

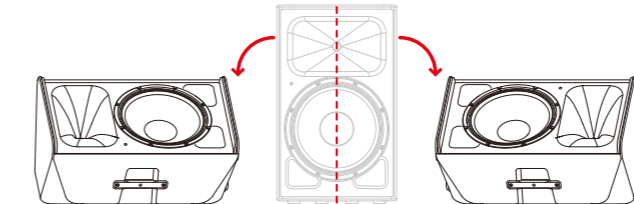

### Dual-Angle Pole Mount Socket

Depending on the venue, sometimes your mix can fall prey to low ceilings or other room attributes that can impede a clear, even sound and significantly detract from the audiences' listening experience. The DXR's pole mount socket offers two positions—0° and 7°—to direct the acoustic energy away from reflective surfaces and on to your audience where it belongs.



Tilt Pole Mount(7°) Normal Pole Mount(0°)

## Perfect for

- ✓ **Front of House Main PA**
- ✓ **Floor Monitoring**
- ✓ **Installation**
- ✓ **Simple Vocal or Instrument Amplification**
- ✓ **Side-fill**
- ✓ **and more...**

From the outset, every aspect of the DXR's design and configuration was carefully scrutinized to ensure it would be perfectly suited to a variety of functions and different applications. This dedication to detail resulted in what is quite simply the most versatile speaker we have ever designed. Featuring a compact, versatile construction, flexible in/out configuration, mixing capability and optimized dynamic processing, never before has a single speaker been so perfectly suited to so many vastly different situations.

## DXR Series

### Active Subwoofers

# DXS Series

DXS12 DXS15

## POWER IN VERSATILITY

Yamaha introduces a new line of compact, high output active subwoofers that match perfectly with DSR and DXR full-range active loudspeakers.

The DXS Series has an all-new band-pass design that produces extremely high SPL by drastically reducing the distortion. The DXS features a customized, high-power handling woofer with superior damping, for a clean, accurate delivery of the massive power produced by a 950W Class-D high-efficiency amplifier. Yamaha's formidable DSP technologies are perfectly utilized for precise tuning of filters, flexible control of the LPF setting and low-frequency response, as well as high-grade protection functions that ensure all components perform to the full limit of their potential. Powerful D-XSUB processing allows you to choose from either NORMAL, BOOST or XTENDED LF settings. NORMAL mode gives you the ideally balanced low-frequency response, while BOOST mode provides a more tight and focused bass. XTENDED LF mode drops the low end frequencies down even further for thunderous bottom end that delivers.

Take your full-range system to the next level with the power and versatility of DXS Series active subwoofers.

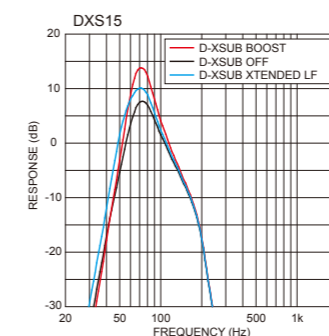

■ DXS Series  
Band-Pass Type Enclosure



8" 2-way Active Loudspeaker

# DXR 8

The most compact of the DXR Series speakers, the DXR8 makes the most of its 1100W of power, delivering extremely high output while maintaining outstanding resolution. Adding a DXS12 subwoofer gives you an ultra-compact high-power SR system.

10" 2-way Active Loudspeaker

# DXR10

Portable, yet capable of producing an astonishing 131 dB SPL, the DXR10's compact, functional design makes it ideal for a wide range of applications. Whether providing simple vocal/instrument amplification, very powerful floor monitoring or comprising a compact SR system—the DXR10 delivers without compromising sound quality and power.

12" 2-way Active Loudspeaker

# DXR12

The DXR12 is an extremely high-power loudspeaker that is capable of producing a maximum SPL of 132dB with its impressive 1100W of power. It is the perfect solution for live sound applications that demand wide bandwidth and extremely high-resolution sound.

15" 2-way Active Loudspeaker

# DXR15

The DXR15 achieves class-leading SPLs and full bandwidth performance by combining a powerful Class-D amplifier with a high-power woofer and Yamaha's cutting edge technologies. Throw in some D-CONTOUR and you'll feel like you're using a subwoofer.

12" Active Subwoofer

# DXS12

The DXS12 is an extremely compact and powerful subwoofer equipped with a high-efficiency 950W Class-D amplifier and a 12" high-output woofer housed in an acoustically optimized band-pass enclosure. Try out our powerful D-XSUB low frequency processing for low-end you would never expect from a compact 12" subwoofer.

15" Active Subwoofer

# DXS15

The all-new DXS15 subwoofer delivers powerful yet focused low end reaching as low as 42Hz. The DXS's fully optimized band-pass design combines with its powerful Class-D amplifier, long-travel 15" woofer, and formidable DSP to deliver a tight, impressive bass with outstanding depth and high power output.



## Dimensions

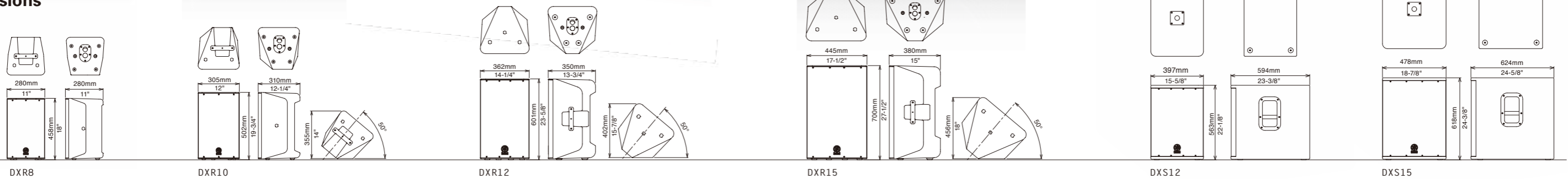

## Rear Panels & Block Diagrams

DXR Series

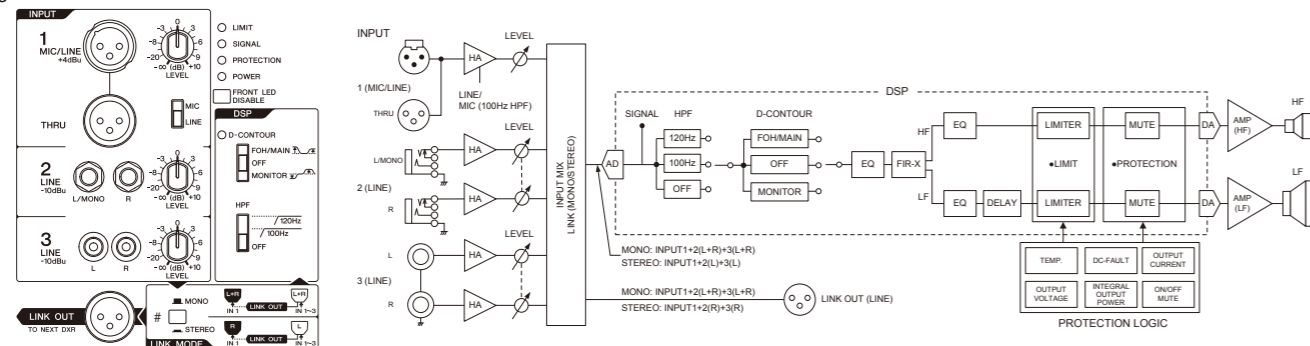

## Rear Panels & Block Diagrams

DXS Series

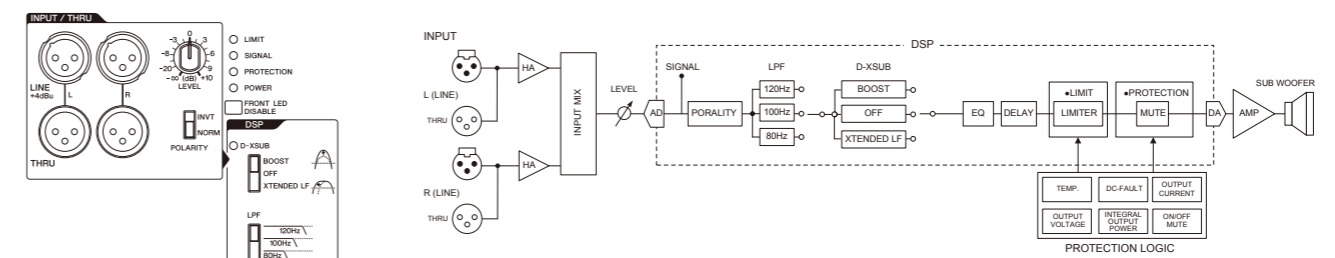



Active Loudspeakers  
**DSR Series**

DSR112 DSR115 DSR215 DSR118W



**POWER PERFECTLY PROCESSED**

The DSR Series represents the ultimate in active loudspeaker systems, delivering the highest output in their class with superior sound resolution—no matter how hard or how long you drive them. We combined decades of real-world experience with our cutting-edge digital and acoustic technologies to give you a powerful listening experience that redefines high-definition sound reinforcement. Light, compact and housed in high-quality wooden enclosures, the DSR Series is the perfect tool for professional musicians, DJ's and entertainers who demand high-definition sound, consistent reliability and serious power.

	Power Rating <sup>*1</sup>	Maximum SPL <sup>*2</sup>	Frequency Range	LF	HF	Coverage Angle
DSR112	1500W	134dB SPL	55Hz-20kHz	12" cone	2" diaphragm, 1" throat	H90°x V60°
DSR115	1500W	136dB SPL	45Hz-20kHz	15" cone	2" diaphragm, 1" throat	H90°x V60°
DSR215	1500W	138dB SPL	45Hz-20kHz	Dual 15" cone	2" diaphragm, 1" throat	H90°x V60°
DSR118W	1000W	132dB SPL	40Hz-130Hz	18" cone	-	-

<sup>\*1</sup> Dynamic Power <sup>\*2</sup> Measured Maximum SPL (peak)

## High-Efficiency 1500W Class-D Amplifiers

### Compact, High-Power Amp Modules



Yamaha's next-generation Class-D amplifiers deliver as much as 1500W\* of power with precision damping for tight and focused sound from compact, lightweight modules. Through the ideal combination of amplifiers, transducers and DSP, the DSR Series loudspeakers provide the highest levels of power in their class and produce SPL up to 138dB, while maintaining precise dynamics and sound reproduction.

\*DSR118W: 1000W

### Full-resonance Switching-Mode Power Supply with PFC



The DSR Series employs a high-efficiency switching-mode power supply with PFC\*. PFC harmonizes the phases of the load current and power supply voltage, maximizing power output and ensuring stable operation under severe conditions. The full-resonance switching method uses both voltage resonance and current resonance, creating a clean power supply waveform with minimal high frequency noise. This clean, efficient power supply enables the entire speaker system to achieve its full performance potential.

\*Power factor Correction

### Efficient Natural Convection Heat Sink and Internal Structure

The heat sink uses high-efficiency cooling fins and is integrated with the aluminum die-cast rear panel. Circuit boards are installed on the back of the rear panel, with all parts including the DSP, amplifiers and power supply laid out to ensure maximum heat conductivity. The entire structure is dedicated to preventing heat build-up, which not only lengthens the service lifetimes of all components, but also ensures that the highest sound quality is realized. For example, the DSP unit is completely shielded to separate it from the amp modules and power supply, preventing noise interference.

## The Finest Audio Components for Optimum Performance

### Premium-Grade Custom-Designed Transducers

Selecting the right transducer is a crucial step in determining the power and sound quality of a speaker. With the DSR Series, we thoroughly analyzed a wide range of transducers, choosing low-distortion units that provide extremely flat frequency response, wide dynamic range and high-power handling. They were further customized to match the properties of each speaker's enclosure and amplifier combination. The result is a high-powered loudspeaker system with impressively deep bass, exceptionally clear mid-range and accurate high frequencies up to 20KHz.



### Exclusive Wide Dispersion Constant Directivity Horn

The DSR constant directivity horn was designed with the goal of minimizing the radiation pattern deterioration in oblique directions seen in conventional horns in order to achieve a more ideal coverage area without irregularities. With the new wide dispersion constant directivity horn, sound expands in a more rectangular pattern, providing 90° horizontal x 60° vertical coverage with wide frequency sound projected all the way to the edges of the coverage area. This uniformly balanced output and high sound quality throughout the listening space maximizes audience satisfaction.

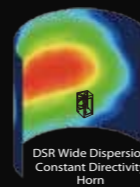
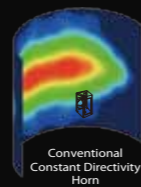

## Reliability and Functionality to Meet the Highest Professional Standards

In addition to the portability their compact configuration affords, DSR Series loudspeakers are built to last. With their durable construction and intuitive design, the DSR Series excels in both physical and electrical reliability, giving you the assurance of worry-free operation for many years to come.

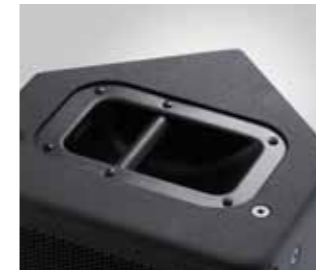

Newly designed deep pocket handles are extremely resilient yet lightweight, providing comfortable handling. These handles are not only ergonomically correct; they also minimize performance-impairing resonances inside the enclosure.



Heavy-duty powder-coated 16-gauge (1.6mm) steel grilles protect internal components from the rigors of road travel.



The exteriors feature a LINE-X® coating with extremely high damage resistance to protect the cabinet from scratches during transport and use. This coating is also very resistant to deterioration over time, maintaining a professional appearance that can withstand many long years of use.



Every model has a locking IEC power connector and cable. Just push in the AC cord to create a positive lock with the amp module, ensuring there is little chance of accidental disconnection during a performance. If damaged or lost, the locking cable can be easily replaced with a standard IEC cable.

## Versatility for Wide Range of Applications

Easy to handle and transport, the four models of the DSR Series are equipped to function in a variety of configurations, making them ideal for an impressive range of professional applications. The DSR112 and DSR115 enclosures come with a 35mm pole socket for stand or pole mounting, as well as integrated M10 rigging points for suspended applications with standard eyebolts\*. Additionally, the DSR112 can be angled for use as an onstage floor monitor and additional speakers can be daisy-chained via the XLR THRU socket on the rear panel. All full-range models also feature XLR and TRS jack inputs that accept both Mic and Line level inputs.

\*eyebolts not included



DSR112 Suspended from integrated M10 rigging points

DSR115 over DSR118W, using speaker pole



DSR112 on speaker stand



DSR112 in floor monitor position

12" 2-way Active Loudspeaker

# DSR112

The DSR112 is the most compact and versatile speaker in the series. Capable of delivering an astonishing peak SPL of 134dB, the DSR112 can be used for both front-of-house sound or floor monitoring applications.



15" 2-way Active Loudspeaker

# DSR115

The DSR115 is a high-power 15" 2-way loudspeaker perfect for situations that require a more prominent bottom end and higher output. With a maximum SPL of 136dB and extremely wide bandwidth the DSR115 ensures a higher level of audience satisfaction.



Dual 15" 2-way Active Loudspeaker

# DSR215

Perfect for live sound applications that require a simple setup and serious power, the DSR215 features two cast-frame 15" woofers, and a neodymium compression driver that faithfully reproduce a wide frequency range—from thunderous lows to soaring highs—with outstanding clarity.



18" Active Subwoofer

# DSR118W

The DSR118W is a compact, high-power subwoofer that can lower the bass frequencies of the DSR full range speakers to below 40Hz. With a high efficiency 1000W Class-D amplifier and a long travel, cast frame 18" woofer, the DSR118W will power your performance with earth-shaking bottom end.



## Dimensions

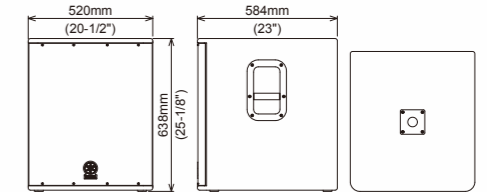
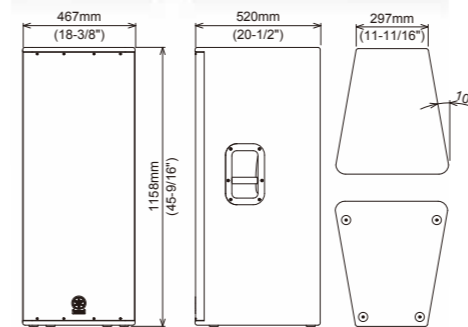
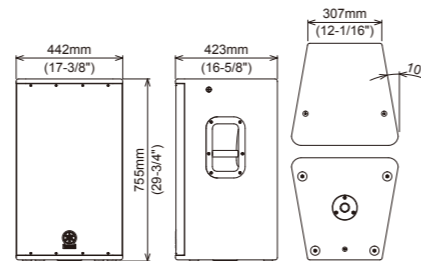
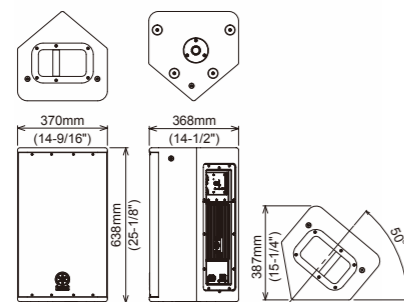

## Rear Panels & Block Diagrams

DSR Series : Full-range models

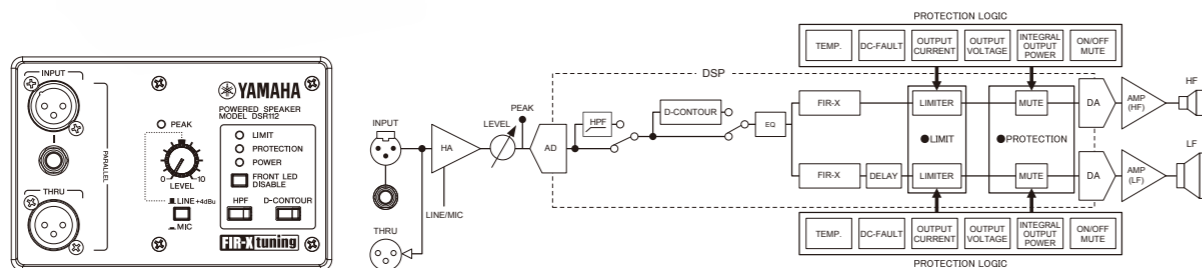

DSR Series : Subwoofer model

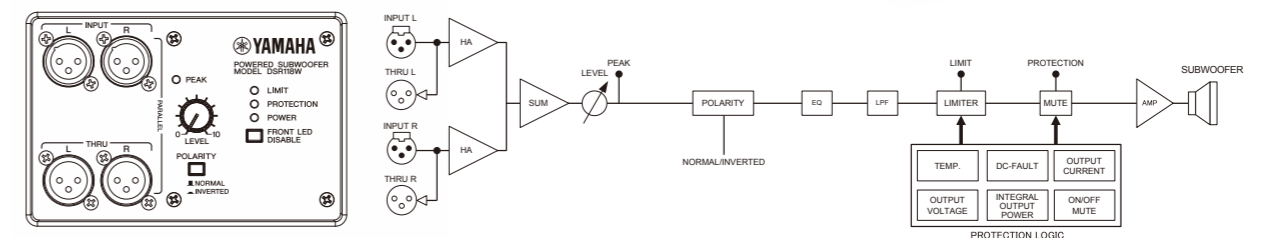

## DXR Series Specifications



DXR8



DXR10



DXR12

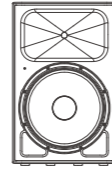

DXR15

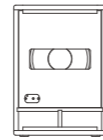

DXS12

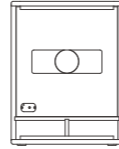

DXS15

General								
System Type	2-way, Bi-amp powered speaker, Bass-reflex type						Powered subwoofer, Band-pass type	
Frequency Range (-10dB)	57Hz – 20kHz	56Hz – 20kHz	52Hz – 20kHz	49Hz – 20kHz	47Hz – 160Hz	45Hz – 160Hz		
Coverage Angle	H90° x V60° constant directivity horn						-	
Crossover Type	FIR-X tuning™ (Linear phase FIR filter)						-	
Crossover Frequency	2.4kHz	2.3kHz	2.1kHz	2.1kHz	-			
Measured Maximum SPL (peak) IEC noise@1m	129dB SPL	131dB SPL	132dB SPL	133dB SPL	131dB SPL	132dB SPL		

Transducer							
LF	Diameter	8" cone	10" cone	12" cone	15" cone	12" cone	15" cone
	Voice Coil	2"	2"	2.5"	2.5"	2.5"	2.5"
	Magnet	Ferrite					
HF	Diaphragm	1.4"					
	Type	1" throat compression driver					
	Magnet	Ferrite					

Enclosure								
Material, Finish, Color	ABS, Matte black						Wood, Paint, Black	
Floor Monitor Angle	-	50°	50° Symmetrical	50° Symmetrical	-			
Dimensions (W x H x D, with rubber feet)	280 x 458 x 280 mm (11" x 18" x 11")	305 x 502 x 310 mm (12" x 19-3/4" x 12-2/8")	362 x 601 x 350 mm (14-1/4" x 23-5/8" x 13-3/4")	445 x 700 x 380 mm (17-1/2" x 27-1/2" x 15")	397 x 563 x 594 mm (15-5/8" x 22-1/8" x 23-3/8")	478 x 618 x 624 mm (18-7/8" x 24-3/8" x 24-1/2")		
Net Weight	13.5kg (29.8lbs)	14.6kg (32.2lbs)	19.3kg (42.5lbs)	22.5kg (49.6lbs)	33.0kg (72.8lbs)	38.0kg (83.8lbs)		
Handles	Aluminium die-cast (Top x 1)			Aluminium die-cast (Side x 2)		Metal (Side x 2)		
Pole Socket	35mm with 2-way feature (0 or 7 degrees)						35mm (Top x 1)	
Rigging Points	Top x 2, Rear x 1 (Fits for M8 x 15mm eyebolts)			Top x 2, Rear x 1 (Fits for M10 x 18mm eyebolts)		-		
Optional Accessory (U-bracket)	UB-DXR8	UB-DXR10	UB-DXR12	UB-DXR15	-			

Amplifier								
Amplifier Type	Class-D						Class-D	
Power Rating*1	Dynamic	1100W (LF: 950W, HF: 150W)				950W		
	Continuous	700W (LF: 600W, HF: 100W)				600W		
Cooling	Fan cooling, 4 speeds							
AD/DA	24bit 48kHz sampling							
Signal Processing	48bit (Accumulator: 76bit)							
HPF/LPF	OFF, 100, 120Hz 24dB/oct HPF				80, 100, 120Hz 24dB/oct LPF			
DSP Preset	D-CONTOUR: FOH/MAIN, MONITOR, OFF				D-XSUB: BOOST, XTENDED-LF, OFF			
Protection	Speaker	Clip limiting, Integral Power Protection, DC-fault						
	Amplifier	Thermal, Output over current						
	Power Supply	Thermal, Output over voltage, Output over current						
Connectors	Input	INPUT1: XLR3-31 x 1, INPUT2: Phone x 2, INPUT3: RCA PIN x 2				INPUT: XLR3-31 x 2		
	Output	THRU: XLR3-32 x 1 (Parallel with INPUT1), LINK OUT: XLR3-32 x 1				THRU: XLR3-32 x 2 (Parallel with INPUT)		
Input Impedance	INPUT1	LINE: 12kΩ, MIC: 8kΩ				10kΩ		
Input Sensitivity (LEVEL: Maximum)	INPUT1	LINE: +1dBu, MIC: -32dBu				+1dBu		
	INPUT2, 3	-13dBu				-		
Input Sensitivity (LEVEL: Center)	INPUT1	LINE: +11dBu, MIC: -22dBu				+11dBu		
	INPUT2, 3	-3dBu				-		
Maximum Input Level	INPUT1	LINE: +24dBu, MIC: +20dBu				+24dBu		
INPUT2, 3	+16dBu				-			
Controls	LEVEL x 3, LINE/MIC, HPF, D-CONTOUR, FRONT LED DISABLE, LINK MODE, POWER				LEVEL, POLARITY, LPF, D-XSUB, FRONT LED DISABLE, POWER			
Idle Power Consumption	35W							
1/8 Power Consumption	90W			110W		120W		
Power Requirements	100V – 240V, 50Hz/60Hz							

\*1 Power rating (120V, 25°C). This is total value of individual output power.

## DSR Series Specifications

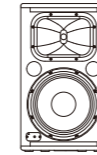

DSR112

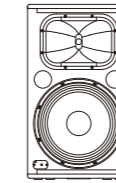

DSR115

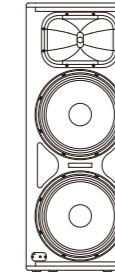

DSR215

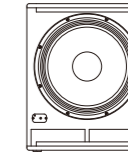

DSR118W

General					
System Type	2-way, Bi-amp powered speaker, Bass-reflex type			Powered subwoofer, Bass-reflex type	
Frequency Range (-10dB)	55Hz - 20kHz	45Hz - 20kHz	45Hz - 20kHz	40Hz - 130Hz	
Coverage Angle	H90° x V60° constant directivity horn			-	
Crossover Type	FIR-X tuning™ (Linear phase FIR filter)			-	
Crossover Frequency	1.7kHz			-	
Measured Maximum SPL (peak) IEC noise@1m	134dB SPL	136dB SPL	138dB SPL	132dB SPL	

Transducer					
LF	Diameter	12" cone	15" cone	2 x 15" cone	18" cone
	Voice Coil	3"	2.5"	3"	
	Magnet	Neodymium		Ferrite	
HF	Diaphragm	2"			-
	Type	1" throat compression driver			-
	Magnet	Neodymium			-

Enclosure				
Material, Finish, Color	Wood, LINE-X®, Black			
Floor Monitor Angle	50°	-	-	-
Dimensions (W x H x D, with rubber feet)	370 x 638 x 368mm (14-9/16" x 25-1/8" x 14-1/2")	442 x 755 x 423mm (17-3/8" x 29-3/4" x 16-5/8")	467 x 1158 x 520mm (18-3/8" x 45-9/16" x 20-1/2")	520 x 638 x 584 mm (20-1/2" x 25-1/8" x 23")
Net Weight	21.2kg (47lbs)	28.0kg (62lbs)	49.8kg (110lbs)	42.0kg (93lbs)
Handles	Metal (Top x 1)	Metal (Side x2)		
Pole Socket	35mm (Bottom x 1)	-		35mm (Top x 1)
Rigging Points	Top x 2, Rear x 1 (Fits for M10 x 18mm eyebolts)		-	
Optional Accessory	-			

Amplifier			
Amplifier Type	Class-D		
Power Rating*1	Dynamic	1500W (LF: 1020W, HF: 480W)	1020W
	Continuous	1300W (LF: 850W, HF: 450W)	800W
Cooling	Natural convection		
AD/DA	24bit 48kHz sampling		
Signal Processing	48bit (Accumulator: 76bit)		
HPF/LPF	OFF, 120Hz 24dB/oct HPF		120Hz 24dB/oct LPF
DSP preset	D-COUNTOR(Dynamic CONTOUR)		
Protection	Speaker	Clip limiting, Integral Power Protection, DC-fault	
	Amplifier	Thermal, Output over current	
	Power Supply	Thermal, Output over voltage, Output over current	
Connectors	Input	XLR-3-31 x 1 TRS Phone Jack x 1	XLR-3-31 x 2
	Output	XLR-3-32 x 1 Parallel with INPUT	XLR-3-32 x 2 Parallel with INPUT
Input Impedance	LINE: 12kΩ, MIC: 8kΩ		
Input Sensitivity (LEVEL: Maximum)	LINE: 0dBu, MIC: -25dBu		
	-		
Input Sensitivity (LEVEL: Center)	LINE: +7dBu, MIC: -18dBu		
	-		
Maximum Input Level	LINE: +24dBu, MIC: -11dBu		
Level	-		
Controls	LEVEL, LINE/MIC, HPF, D-CONTOUR, FRONT LED DISABLE, POWER		
Idle Power Consumption	30W		
1/8 Power Consumption	100W	140W	100W
Power Requirements	North America: 120V, 60Hz, Japan: 100V, 50Hz/60Hz, Other areas: 220 - 240V, 50Hz		