



# CSS8004/CSS8008/ CSS8018

With CSS-BB4 and CSS-BB8 Backcans and CSS-TR4/8 Tile Rails

## 100 mm (4 in) and 200 mm (8 in) Commercial Series Ceiling Speakers for Use with Pre-Install-Type Backcans.

### Commercial Series

### Key Features:

- ▶ Affordably priced, high-quality dual-cone type ceiling speaker.
- ▶ Pre-assembled speaker / transformer / grille assembly.
- ▶ Suitable for most paging or background music applications, including retail stores, restaurants, schools, and other facilities.
- ▶ Very high sensitivity provides maximum sound levels using minimal amplifier power.
- ▶ Quality triple-voltage transformer (100V, 70V and 25V).
- ▶ Packs of six pieces contain individually packaged speakers for shipping non-pack quantities to jobsite.



JBL's Commercial Series Ceiling Speakers provide excellent performance for paging and background music applications. High sensitivity across the product line provides maximum sound level, even at low tap settings.

Model CSS8004 is a 100 mm (4 in) speaker with 90 dB sensitivity and a 5-Watt multi-tap transformer.

Model CSS8008 is an 200 mm (8 in) speaker with high 96 dB sensitivity, greater bass extension than the CSS8004, and a 5-Watt multi-tap transformer.

Model CSS8018 is a higher-power 200 mm (8 in) speaker, with very high 97 dB sensitivity and a larger 10-Watt multi-tap transformer.

The speaker's pre-attached triple-voltage transformer provides versatility by allowing use on 100V, 70V or 25V distributed loudspeaker lines.

The drivers feature a full 25 mm (1 in) diameter voice coil with a Kapton coil-former and high-temperature wire for better power dissipation and long-term reliability. For installation convenience, the speaker grille and transformer are pre-attached to the driver. Grilles are painted, zinc-plated, cold-rolled steel. The 200 mm (8 in) models feature a standard 286 mm (11¼ in) bolt-mounting diameter. Matching CSS backcans are made of zinc-plated steel with powder-coated finish. CSS steel pre-install backcans can be installed, wired, and inspected prior to installation of the speaker.

### Loudspeaker Assemblies:

|   | CSS8004   | CSS8008  | CSS8018  |
|---|---|--|--|
| Driver Size (dual-cone)                                     | 100 mm (4 in)   | 200 mm (8 in)  | 200 mm (8 in)  |
| Driver Sensitivity (mid-range) (1W [2.83V], 1m, 2k – 6k Hz) | 90 dB   | 96 dB  | 97 dB  |
| Frequency Range (-10 dB)                                    | 85 Hz – 18 kHz  | 55 Hz – 16 kHz   | 50 Hz – 17 kHz   |
| Driver/Grille Assembly:<br>Installed in CSS-BB backcan:     | 130 Hz – 18 kHz   | 100 Hz – 16 kHz  | 90 Hz – 17 kHz   |
| Coverage (2 kHz)  | 175°  | 120°   | 110°   |
| Driver Continuous Power Handling <sup>1</sup>               | 15 Watts  | 15 Watts   | 20 Watts   |
| 100V Taps   | 5W, 2.5W, 1.3W  | 5W, 2.5W, 1.3W   | 10W, 5W, 2.5W  |
| 70V Taps  | 5W, 2.5W, 1.3W, 0.7W  | 5W, 2.5W, 1.3W, 0.7W   | 10W, 5W, 2.5W, 1.3W  |
| 25V Taps  | 5W, 2.5W, 1.3W, 0.7W  | 5W, 2.5W, 1.3W, 0.7W   | 10W, 5W, 2.5W, 1.3W  |
| Transformer Insertion Loss                                  | 1.5 dB Maximum  | 1.5 dB Maximum   | 1.5 dB Maximum   |
| Transformer Connection                                      | Bare wire   | Bare wire  | Bare wire  |
| Motor Mass  | 200 g (7 oz)  | 200 g (7 oz)   | 283 g (10 oz)  |
| Safety Agency   | Suitable for use in air handling spaces per UL1480, UL2043, NFPA 90 & NFPA 70, when installed with corresponding UL Listed backcan, below. S7232/UL Listed, Signaling Speaker. Transformer UL registered per UL1876. In accordance with IEC60849/EN60849. |  |  |
| Matching CSS Backcan  | CSS-BB4   | CSS-BB8 (0.15 cu ft)   | CSS-BB8 (0.15 cu ft)   |
| Other Compatible Backcans                                   | n/a   | MTC-81BB8 (0.26 cu ft)<br>MTC-200BB6 (0.5 cu ft)<br>MTC-300BB8 (1.0 cu ft) | MTC-81BB8 (0.26 cu ft)<br>MTC-200BB6 (0.5 cu ft)<br>MTC-300BB8 (1.0 cu ft) |
| Bolt Mounting Circle to Backcan                             | 4 points on 165 mm (6.5 in) diameter  | 4 points on 286 mm (11.25 in) diameter                                     | 4 points on 286 mm (11.25 in) diameter                                     |
| Cutout Diameter   | 125 mm (5.0 in)   | 216 mm (8.5 in)  | 216 mm (8.5 in)  |
| Open-back:<br>In CSS-BB backcan                             | 170 mm (6.7 in)   | 295 mm (11.7 in)   | 295 mm (11.7 in)   |
| Depth (behind grille)                                       | 94 mm (3.7 in)  | 71 mm (2.8 in)   | 73 mm (2.9 in)   |
| Grille Diameter   | 198 mm (7.8 in)   | 327 mm (12.9 in)   | 327 mm (12.9 in)   |
| Net Weight (ea)   | 0.90 kg (1.0 lb)  | 1.27 kg (2.8 lb)   | 1.58 kg (3.5 lb)   |
| Shipping Weight (ea)  | 1.26 kg (2.8 lb)  | 1.94 kg (4.3 lb)   | 2.25 kg (5.0 lb)   |
| Included Accessories  | 4 pcs M4 x 40 mm sheet metal screws for attaching speaker/driver/transformer assembly to corresponding backcan.   |  |  |

<sup>1</sup> Continuous Pink Noise Rating (IEC-shaped pink noise with a 6 dB crest factor, for 100 hrs continuously), 2.83V input level.

JBL continually engages in research related to product improvement. Some materials, production methods and design refinements are introduced into existing products without notice as a routine expression of that philosophy. For this reason, any current JBL product may differ in some respect from its published description, but will always equal or exceed the original design specifications unless otherwise stated.

# ► CSS8004/CSS8008/CSS8018 Commercial Series Ceiling Speakers

## Backcans & Tile Rails

|                      | CSS-BB4   | CSS-BB8   | CSS-TR4/8  |
|----------------------|---|---|--|
| Compatibility        | CSS-8004 speaker, CSS-TR4/8 tile rails  | CSS-8008 and CSS-8018 speakers, CSS-TR4/8 tile rails                      | CSS-BB4 and CSS-BB8 backcans   |
| Dimensions           | 89 deep x 214 diameter mm (3.5 x 8.4 in)  | 108 deep x 334 diameter mm (4.3 x 13.2 in)                                | 600 x 36 x 8 mm (23.6 x 1.4 x 0.3 in)  |
| Bolt Mount Circle    | 4 points on 165 mm (6.5 in) diameter  | 4 points on 286 mm (11.25 in) diameter                                    | n/a  |
| Air Space            | 1.4 liters (0.05 cu ft)   | 4.0 liters (0.15 cu ft)   | n/a  |
| Material             | Steel, zinc-plated, powder-coated   | Steel, zinc-plated, powder-coated   | Punched/formed steel, zinc-plated  |
| Conduit Knockouts    | Five (5) knockouts: 4 on sides spaced at 90° and 1 at center of top panel   | Five (5) knockouts: 4 on sides spaced at 90° and 1 at center of top panel | n/a  |
| Attachment Points    | 4 points on 165 mm (6.5 in) diameter with clip nuts for 4 screws.   | 4 points on 286 mm (11.25 in) diameter. Clip nuts for 4 screws.           | 2 points screw onto backcan, each rail.  |
| Safety Agency        | Suitable for use in air handling spaces per UL1480, UL2043, NFPA 90 & NFPA 70, when installed with corresponding UL Listed loudspeaker, above. S7232/UL Listed, Signaling Speaker. CUL Listed. In accordance with IEC60849/EN60849. |   |  |
| Net Weight (ea)      | 0.38 kg (0.9 lb)  | 0.87 kg (2.0 lb)  | 0.18 kg (0.4 lb)   |
| Shipping Weight (ea) | 0.47 kg (1.1 lb)  | 1.04 kg (2.3 lb)  | 0.21 kg (0.5 lb)   |
| Included Accessories | 4 pcs M4 x 8 mm machine screws for attaching two tiles rails to backcan   |   | <i>(M4 x 8 mm machine screws for attaching rails are packaged with backcans)</i> |

## Frequency Response & Impedance

Transformer bypassed, 10° off-axis (typical for coverage area), driver/grille assembly

### CSS8004

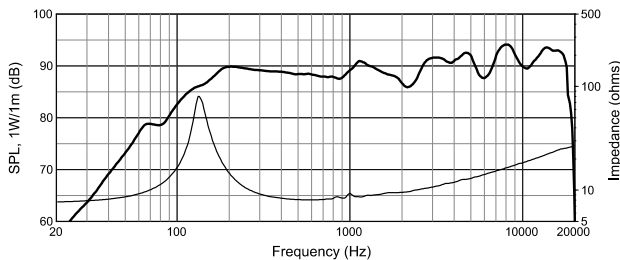

### CSS8008

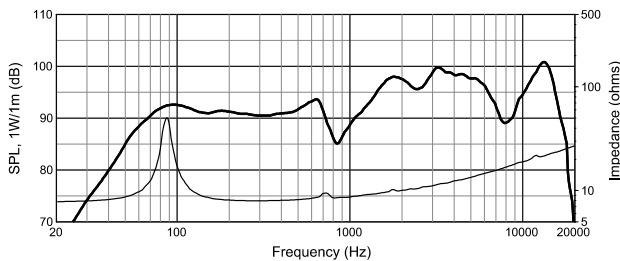

### CSS8018

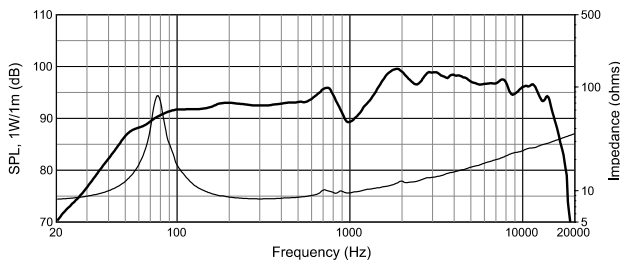

## Connection:

### CSS8004 and CSS8008

|      | Orange | Green | Gray  | Yellow | Black |
|------|--------|-------|-------|--------|-------|
| 25V  | 0.7W   | 1.3W  | 2.5W  | 5W     | COM   |
|      | White  | Blue  | Brown | Orange | Black |
| 70V  | 0.7W   | 1.3W  | 2.5W  | 5W     | COM   |
| 100V | 1.3W   | 2.5W  | 5W    | N/C    | COM   |

### CSS8018

|      | Orange | Green | Gray  | Yellow | Black |
|------|--------|-------|-------|--------|-------|
| 25V  | 1.3W   | 2.5W  | 5W    | 10W    | COM   |
|      | White  | Blue  | Brown | Orange | Black |
| 70V  | 1.3W   | 2.5W  | 5W    | 10W    | COM   |
| 100V | 2.5W   | 5W    | 10W   | N/C    | COM   |

Coverage:

CSS8004

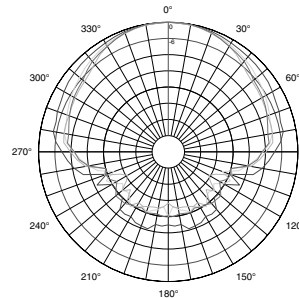
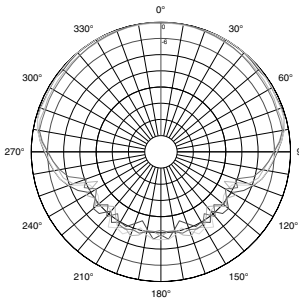
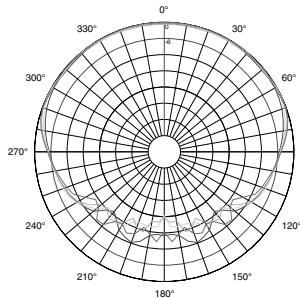

CSS8008

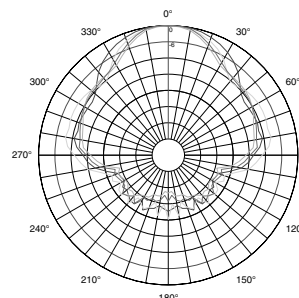
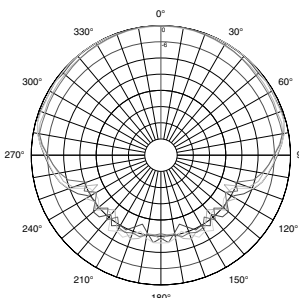
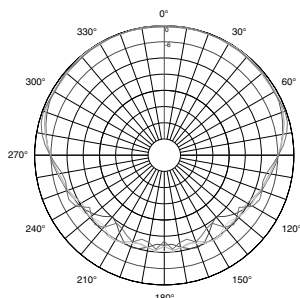

CSS8018

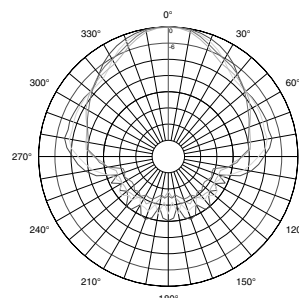
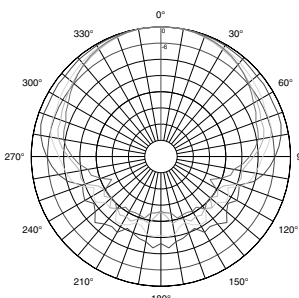
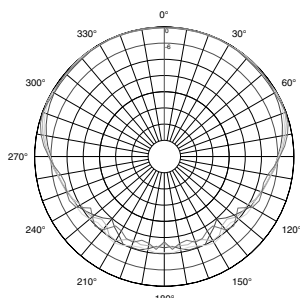

Assembly:

CSS8004

**Tile Rails CSS-TR4/8(X2)**  
Secure rails to ceiling/grids in manner required by local building code.

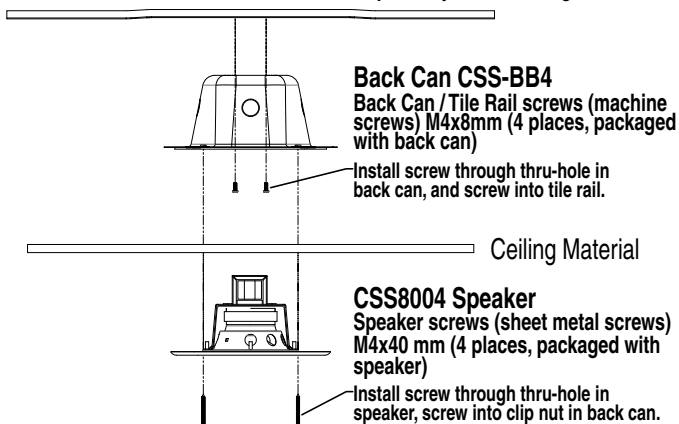

CSS8008 & 8018

**Tile Rail CSS-TR4/8(x2)**  
Secure to ceiling/grids in manner required by local building code.

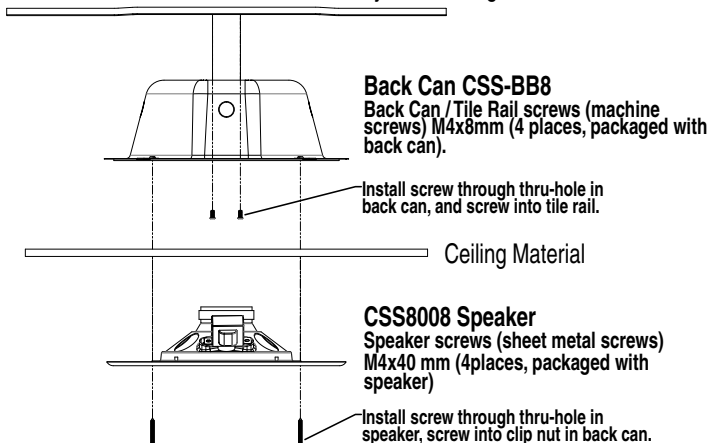

# ► CSS8004/CSS8008/CSS8018 Commercial Series Ceiling Speakers

Dimensions:

CSS8004

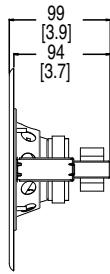
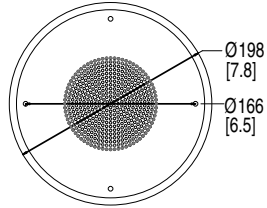

CSS8008 and  
CSS8018

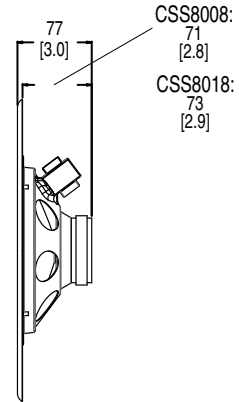
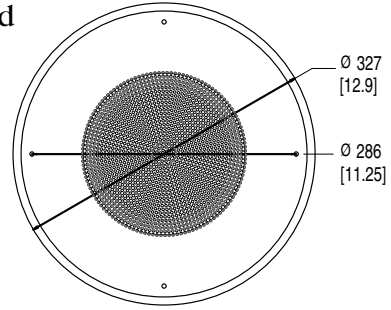

CSS-BB4

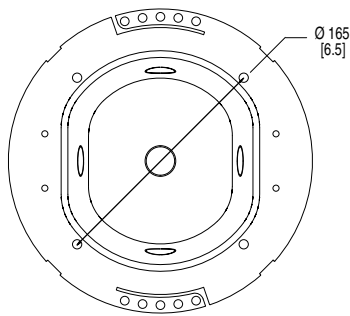
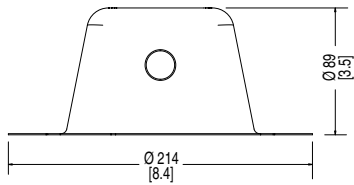

CSS-BB8

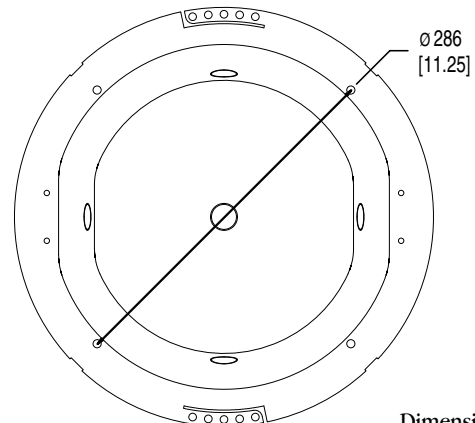
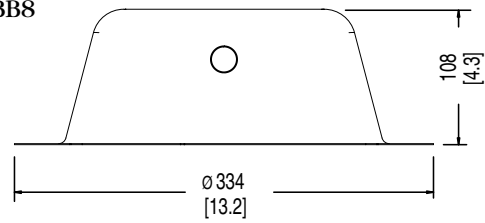

Dimensions in mm (in)

CSS-TR4/8

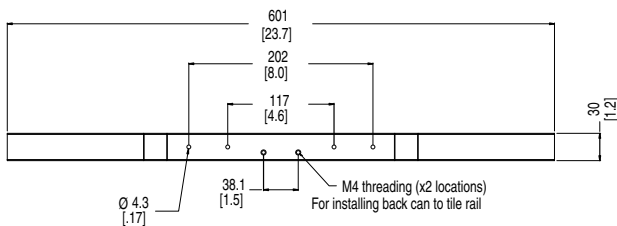

JBL Professional  
8500 Balboa Boulevard, P.O. Box 2200  
Northridge, California 91329 U.S.A.