

BOOMER X2/TZ

USER MANUAL

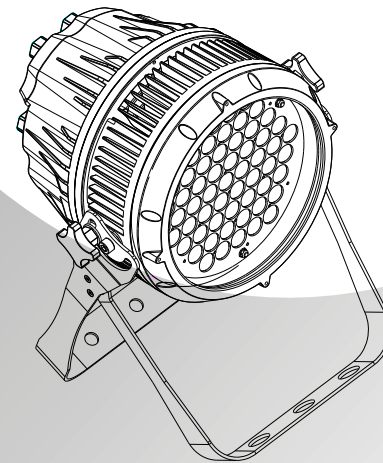

YG-LED332

 **SILVER STAR**
Professional Lighting

www.yajiang.cn

RD-SS332-SM-00(SS-I)

V:#001

MODELS: YG-LED332XW/YG-LED332XWT

T ABLE OF CONTENTS

PART 1 PRODUCT (GENERAL)	1.
1.1--TECHNICAL SPECIFICATIONS.....	1.
1.2--SAFETY WARNING.....	2.
PART 2 INSTALLATION	3.
2.1--MOUNTING.....	3.
2.2--POWER CONNECTION.....	3.
PART 3 DISPLAY PANEL OPERATION	3.
3.1--BASIC.....	3.
3.2--MENU.....	4.
3.3--EDIT STATIC COLOUR.....	5.
3.4--ACTIVATING AUTO PROGRAMS.....	5.
3.5--DMX512 SETTINGS.....	5.
3.6--RUN MODE.....	6.
3.7--PERSONALITY.....	6.
3.8--EDITING CUSTOM PROGRAMS.....	6.
3.9--SPECIAL SETTINGS.....	7.
3.10--WHITES SETTING.....	7.
3.11--WHITES BALANCE.....	8.
3.12--ACTIVATE THE PASSWORD.....	8.
3.13--RGB CALIBRATION.....	8.
3.14--ZOOM RANGE.....	8.
PART 4 USING A DMX512 CONTROLLER	9.
4.1--BASIC ADDRESSING.....	9.
4.2--CHANNEL ASSIGNMENT.....	9.
PART 5 APPENDIX	13.
5.1--MAINTENANCE.....	13.

5.1 MAINTENANCE

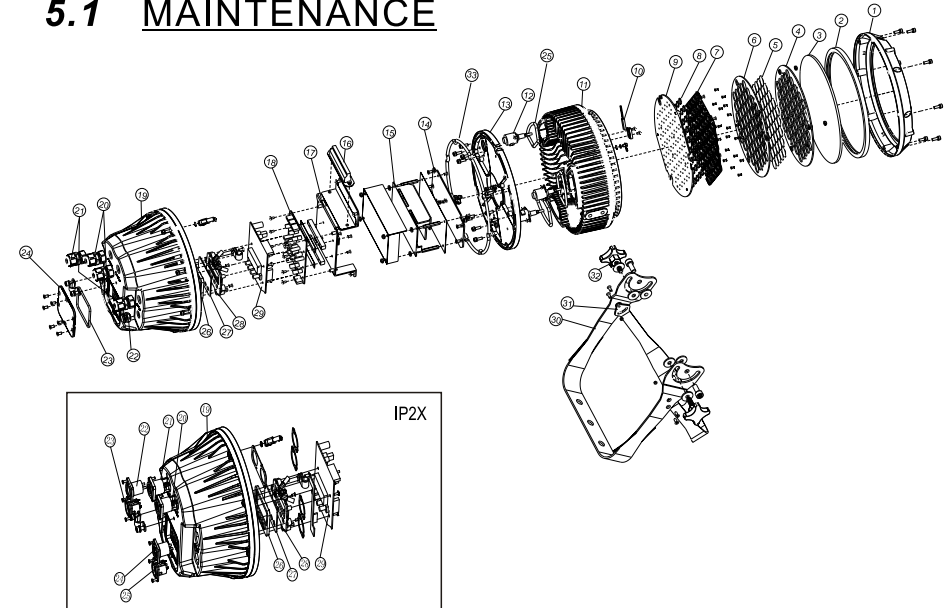

No	ITEM(IP2X)	ITEM(IP 66)
1	Head cover	Head cover
2	Rubber seal	Rubber seal
3	Clear glass	Clear glass
4	Lens holder up	Lens holder up
5	Zoom lens	Zoom lens
6	Lens holder down	Lens holder down
7	Lens base	Lens base
8	Capture lens	Capture lens
9	LED board	LED board
10	Thermal protection device	Thermal protection device
11	Head structure	Head structure
12	Motor	Motor
13	Connection disk	Connection disk
14	Power supply support	Power supply support
15	Power supply	Power supply
16	Connection boardd	Connection boardd
17	Drive support	Drive support
18	Prive PCB	Prive PCB
19	Casing2	Casing1
20	Power adaptor	Waterproof button
21	Power adaptor	Waterproof button
22	3 XLR socket(male)	Waterproof dustproof film
23	5 XLR socket(male)	Seal for display metal plate
24	3 XLR socket(female)	Waterproof coverboard
25	5 XLR socket(female)	Connection disk waterproof
26	Button seal	Button seal
27	Display lens	Display lens
28	Button board	Button board
29	Display PCB	Display PCB
30	Abracket2	Abracket2
31	Secondary bracket	Secondary bracket
32	Adjusting stainless steel knob	Adjusting stainless steel knob
33		Weather-proof base section

Ar2.d

CHANNEL	VALUE	FUNCTION
1	0 ↔ 255	MASTER DIMMER
2	0 ↔ 255	RED
3	0 ↔ 255	GREEN
4	0 ↔ 255	BLUE
5	0 ↔ 255	WHITE

Ar2.s

CHANNEL	VALUE	FUNCTION
1	0 ↔ 255	MASTER DIMMER
2	0 ↔ 255	RED
3	0 ↔ 255	GREEN
4	0 ↔ 255	BLUE
5	0 ↔ 255	WHITE
6	0 ↔ 255	STROBE

HSV

CHANNEL	VALUE	FUNCTION
1	0 ↔ 255	HUE(0~100%)
2	0 ↔ 255	SATURATION(0~100%)
3	0 ↔ 255	VALUE(0~100%)

1.1 TECHNICAL SPECIFICATIONS

LED MODULE

Type	Model	Voltage	Operation Temperature	Weight	Dimensions 2 (mm)	Power (W)	IP
I	R:3Wx17 G:3Wx17 B:3Wx17 W:3Wx10	AC100~240V 50/60Hz	-40~45	8.42	357x302x237mm	180	IP2X
II	R:3Wx17 G:3Wx17 B:3Wx17 W:3Wx10			8.34	311x302x237mm	180	IP66

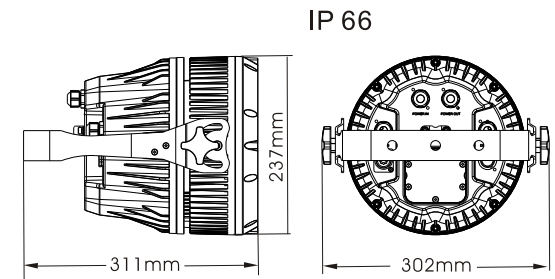
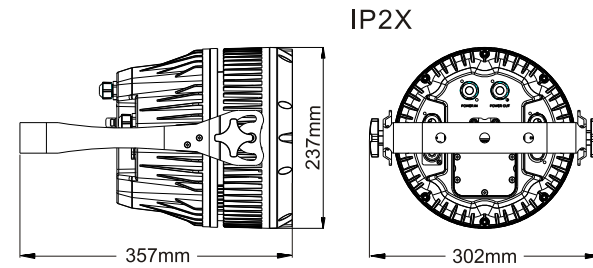

1.2 SAFETY WARNING

IMPORTANT

[ALWAYS READ THE USER MANUAL BEFORE OPERATION.]
[PLEASE CONFIRM THAT THE POWER SUPPLY STATED ON THE PRODUCT IS THE SAME AS THE MAINS POWER SUPPLY IN YOUR AREA.]

- This product must be installed by a qualified professional.
- Always operate the equipment as described in the user manual.
- A minimum distance of 0.5m must be maintained between the equipment and combustible surface.
- The product must always be placed in a well ventilated area.
- Always make sure that the equipment is installed securely.
- DO NOT stand close to the equipment and stare directly into the LED light source.
- Always disconnect the power supply before attempting maintenance.
- Always make sure that the supporting structure is solid and can support the combined weight of the products.
- The earth wire must always be connected to the ground.
- Do not touch the power cables if your hands are wet.

ATTENTION



- This product left the place of manufacture in perfect condition. In order to maintain this condition and for safe operation, the user must always follow the instructions and safety warnings described in this user manual.
- Avoid shaking or strong impacts to any part of the equipment.
- Make sure that all parts of the equipment are kept clean and free of dust.
- Always make sure that the power connections are connected correct and secure.
- If there is any malfunction of the equipment, contact your distributor immediately.
- When transferring the product, it is advisable to use the original packaging in which the product left the factory.
- Shields, lenses or ultraviolet screens shall be changed if they have become damaged to such an extent that their effectiveness is impaired.
- It is important that the power cable is frequently inspected to ensure that there is no damage in any position. If the power cable is damaged in any way, it should be replaced by a qualified electrical technician.
- The lamp (LED) shall be changed if it has become damaged or thermally deformed.

Arc.1

CHANNEL	VALUE	FUNCTION
1	0 ↔ 255	RED
2	0 ↔ 255	GREEN
3	0 ↔ 255	BLUE

Ar1.d

CHANNEL	VALUE	FUNCTION
1	0 ↔ 255	MASTER DIMMER
2	0 ↔ 255	RED
3	0 ↔ 255	GREEN
4	0 ↔ 255	BLUE

Arc.2

CHANNEL	VALUE	FUNCTION
1	0 ↔ 255	RED
2	0 ↔ 255	GREEN
3	0 ↔ 255	BLUE
4	0 ↔ 255	WHITE

CHANNEL	VALUE	FUNCTION
6	231↔235	WHITE 7: 6500K
	236↔240	WHITE 8: 7200K
	241↔245	WHITE 9: 8000K
	246↔250	WHITE 10: 8500K
	251↔255	WHITE 11: 10000K
7		STROBE
	0↔10	NO FUNCTION
	11↔255	1~20Hz
8		AUTO
	0↔20	NO FUNCTION
	21↔30	AUTO 1
	31↔40	AUTO 2
	41↔50	AUTO 3
	51↔60	AUTO 4
	61↔70	AUTO 5
	71↔80	AUTO 6
	81↔90	AUTO 7
	91↔100	AUTO 8
	101↔110	AUTO 9
	111↔120	AUTO 10
	121↔130	CUSTOM 1
	131↔140	CUSTOM 2
	141↔150	CUSTOM 3
	151↔160	CUSTOM 4
	161↔170	CUSTOM 5
	171↔180	CUSTOM 6
	181↔190	CUSTOM 7
	191↔200	CUSTOM 8
	201↔210	CUSTOM 9
	211↔220	CUSTOM 10
221↔255	NO FUNCTION	
9		AUTO SPEED ADJUSTMENT
	0↔255	When using CH8.AUTO01-AUTO10, this function activated
10		DIMMER SPEED
	0↔9	PRESET DIMMER SPEED FROM DISPLAY MENU
	10↔29	LINEAR DIMMER
	30↔69	NON LINEAR DIMMER 1 (fastest)
	70↔129	NON LINEAR DIMMER 2
	130↔189	NON LINEAR DIMMER 3
	190↔255	NON LINEAR DIMMER 4 (slowest)
11	0↔255	ZOOM
12	000↔200	NO FUNCTION
	201↔220	ZOOM RESET
	221↔255	NO FUNCTION

2 INSTALLATION

2.1 MOUNTING

HANGING

The fixture can be mounted in a hanging position using the supporting bracket. The bracket should be secured to the mounting truss or structure using a standard mounting clamp. Please note that when hanging the unit a safety cable should also be used.

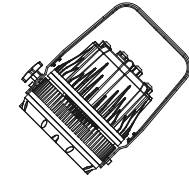

UPRIGHT

The fixture can be mounted in an upright or sitting position using the supporting brackets.

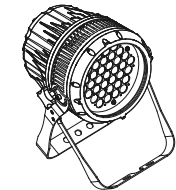

NOTE

The LED MODULE can be mounted at any angle and in any position. It is possible to further adjust the angle of the LED MODULE using the two adjustment knobs located on the side of the fixture.

2.2 POWER CONNECTIONS

@ 220V: 14 units may be connected in series

@120V: 7 units may be connected in series

Note:

If the signal cable is over 60m between the DMX512 controller and fixture or between two fixtures, then a DMX signal amplifier is needed as well.

3 DISPLAY PANEL OPERATION

3.1 BASIC

[MENU] scroll through the main menu or return to the main menu.

[ENTER] enter the currently selected menu or confirm the current function value.

[UP] scroll 'UP' through the menu list or increase the value of the current function.

[DOWN] scroll 'DOWN' through the menu list or decrease the value of the current function.

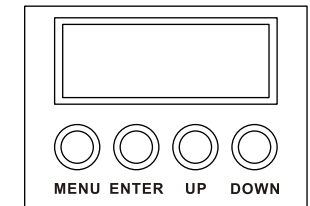

3.2 MENU

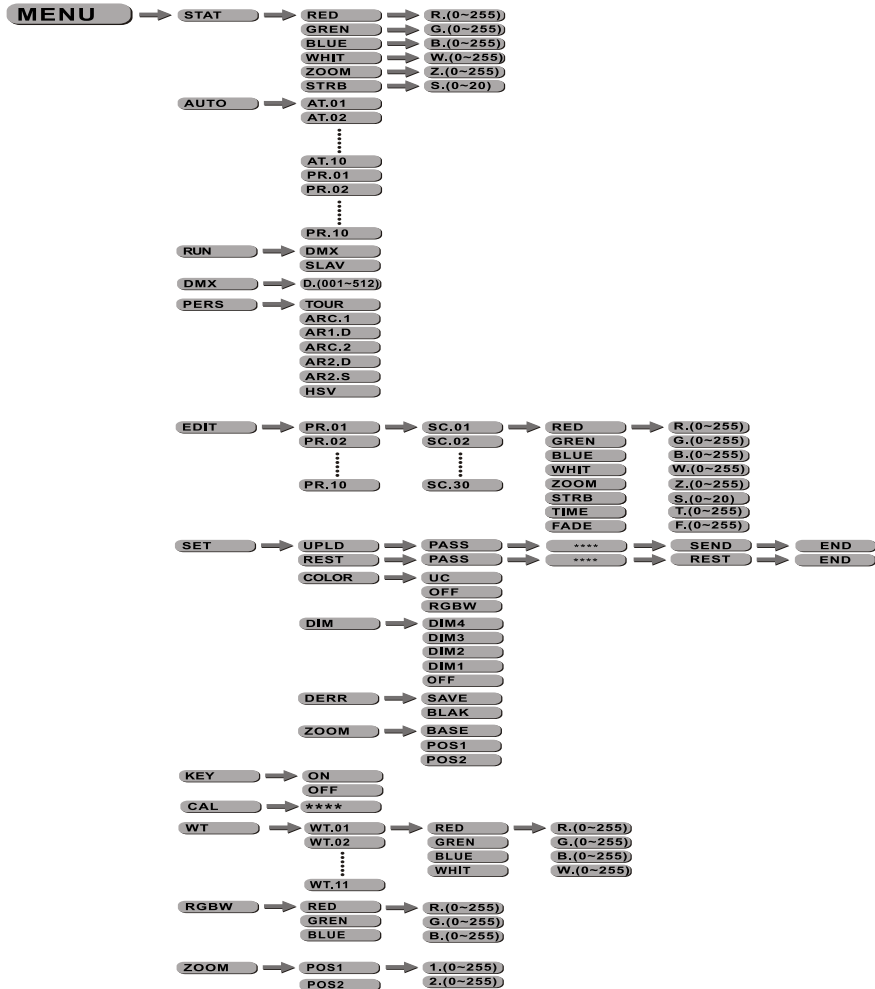

4 USING A DMX512 CONTROLLER

4.1 BASIC ADDRESSING

- Connect all of the units in series using standard DMX512 signal cable or the IP65 rated cable provided.
- Set the DMX512 address in the **[DMX]** menu.
- It is possible to have the same DMX address or independent addresses for each fixture.

4.2 CHANNEL ASSIGNMENT

- Note: This product has three DMX512 channel configuration: **[TOUR]**, **[Arc.1]**, **[Ar1.d]**, **[Arc.2]**, **[Ar2.d]**, **[Ar2.s]** and **[HSV]**

TOUR

CHANNEL	VALUE	FUNCTION
1	0 ↔ 255	MASTER DIMMER
2	0 ↔ 255	RED (or STEP TIME when CUS.01-CUS.10 in CH8 is activated)
3	0 ↔ 255	GREEN (or FADE TIME when CUS.01-CUS.10 in CH8 is activated)
4	0 ↔ 255	BLUE
5	0 ↔ 255	WHITE
6	0 ↔ 5	COLOR MACRO NO FUNCTION
	11 ↔ 30	RED 100%/GREEN UP/BLUE 0%
	31 ↔ 50	RED DOWN/GREEN 100%/BLUE 0%
	51 ↔ 70	RED 0%/GREEN 100%/BLUE UP
	71 ↔ 90	RED 0%/GREEN DOWN/BLUE 100%
	91 ↔ 110	RED UP/GREEN 0%/BLUE 100%
	111 ↔ 130	RED 100%/GREEN 0%/BLUE DOWN
	131 ↔ 150	RED 100%/GREEN UP/BLUE UP
	151 ↔ 170	RED DOWN/GREEN DOWN/BLUE 100%
	171 ↔ 200	RED 100%/GREEN 100%/BLUE 100%/WHITE 100%
	201 ↔ 205	WHITE1: 3200K
	206 ↔ 210	WHITE2: 3400K
211 ↔ 215	WHITE3: 4200K	
216 ↔ 220	WHITE4: 4900K	
221 ↔ 225	WHITE5: 5600K	
226 ↔ 230	WHITE6: 5900K	

3.11 EXTRA



◆ When the user enter **【CAL】** and input the correct password, the hidden menu **【Cablid】** , **【default】** will appear on display panel, and the user is able to reset the **【DEFAULT】** values of all functions.

The default access code is UP + DOWN + UP + DOWN..

3.12 WHITES CALIBRATION

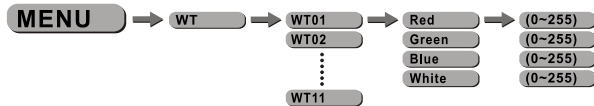

【WT】

- Enter the **【CAL1】** to select white color of different color temperature.
- There are 11 pre-programmed White colors can be edited by using **【Red】** , **【Green】** , **【Blue】** & **【White】** .

3.13 RGB CALIBRATION

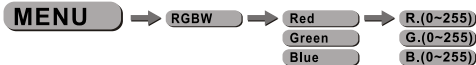

【RGBW】

- Enter the **【MENU】** to adjust the RGBW parameter to make different whites.
- When the new setting is activated, the DMX controller choose RGB = 255,255,255, the white color will be made by the actual RGBW values on the **【RGBW】** .

3.14 ZOOM RANGE



【ZOOM】

- Select the **【ZOOM】** range. **【POS1】** & **【POS2】** set the small position for the zoom function. Note that when using DMX to control the fixture, the user will only be able to access up to the set ZOOM position. It is not possible to adjust beyond the set position.

3.3 EDIT STATIC COLOUR



【STATIC COLOUR】

- Combine **【Red】** , **【Green】** , **【Blue】** and **【White】** to create an infinite range of colors (0-255)
- Set the value of the **【Strobe】** (0-20Hz)
- Set the projection angle by using the **【ZOOM】**

3.4 ACTIVATING AUTO PROGRAMS

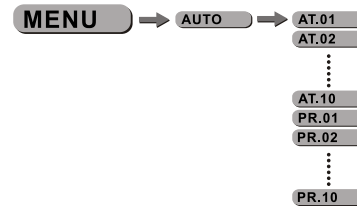

【AUTO】

- Select the target **【AUTO】** program and press **【ENTER】** .
- Programs **【AT.01】** to **【AT.10】** are fully pre-programmed and will not be altered by changes in **【EDIT】** mode.
- Programs **【PR.01】** to **【PR.10】** are fully pre-programmed and can be edited in **【EDIT】** mode.

3.5 RUN MODE



【RUN】

- Enter the **【RUN】** mode to set working mode.
- **【DMX】** mode is for using the DMX512 controller to control the fixtures.
- **【SLAV】** mode is for Master -- Slave operation.

3.6 DMX512 SETTINGS



【DMX】

- Enter the **【DMX】** mode to set the DMX ADDRESS.

3.7 PERSONALITY

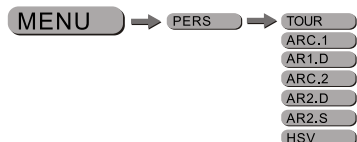

【PERSONALITY】

- Enter the **【PERSONALITY】** mode to select DMX mode: **【TOUR】** , **【ARC.1】** , **【AR1.D】** , **【ARC.2】** , **【AR2.D】** , **【AR2.S】** , **【HSV】** .

3.8 EDITING CUSTOM PROGRAMS

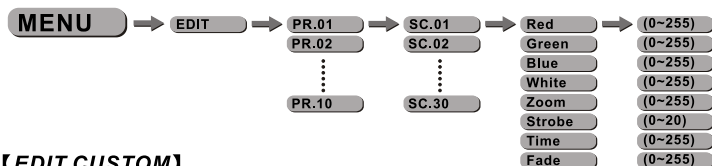

【EDIT CUSTOM】

- Enter the **【EDIT】** mode to edit the custom programs **【PR.01】** to **【PR.10】** .
- Each custom program has 30 steps that can be edited.
- Each step allows the creation of a scene using RED **【Red】** , GREEN **【Green】** , BLUE **【Blue】** , WHITE **【White】** , ZOOM **【ZOOM】** , STROBE **【Strobe】** , TIME **【Time】** & FADE **【Fade】** .

3.9 SPECIAL SETTINGS

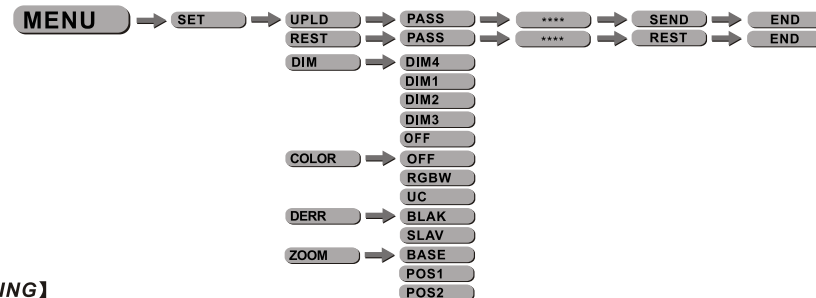

【SETTING】

- Select **【UPLD】** to upload the custom programs from the current MASTER unit to the SLAVE units.
- In order to activate the upload function the password must be entered.
- Password is the same as the main access password.
- When uploading the MASTER and SLAVE units will display YELLOW.
- If an error occurs when uploading the MASTER and/or SLAVE units will display RED.
- On successful uploading of the custom programs the MASTER and SLAVE units will display GREEN.
- In order to reset custom modes to default values select **【REST】** .
- **【COLOR】** is for activate/unactivate the color calibration functions.

When **【RGBW】** is selected, on RGB = 255,255,255, the color is displayed as calibrated in CAL2 -- RGBW. When **【COLOR】** is set **【OFF】** , on RGB = 255,255,255, the RGB values are not adjusted and the output is most powerful.

When **【UC】** is selected, the RGB output are adjusted to a standard preset universal color which balances fixtures from different generations.

- **【DERR】** Choose **【Save】** in order to save the last DMX data incase of DMX signal error. Choose **【Black】** in order to blackout in case of DMX signal error.
- **【ZOOM】** Calibrate the position of POS1&POS2. Set position as 0 for smallest zoom position. selectf BASE for default zoom position (zoom=0)

3.10 ACTIVATE THE PASSWORD



【KEY】

- Enter the **【KEY】** mode to select whether the access password is on or off.
- When the fixture is set as PASS **【ON】** , after 30 seconds or turn on the fixture next time, the fixture will need an access password to enter the display menu control.

Note: The factory access password is **【UP】** + **【DOWN】** + **【UP】** + **【DOWN】** , then press **【ENTER】** to confirm the access.