

SOLAR2 ze/ETZ

USER MANUAL

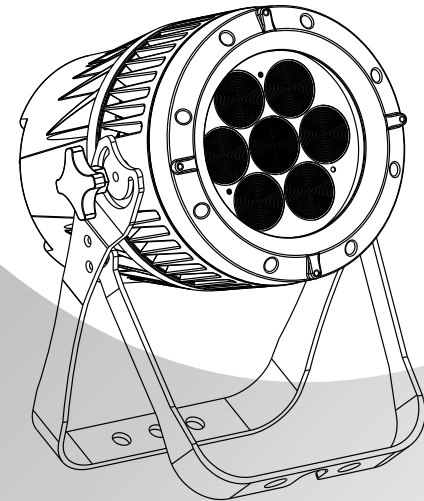

SS345

MODELS:SS345XCEM

 **SILVER STAR**
Professional Lighting

www.yajiang.cn

RD-SS345-SM-03(SS-I)

1 PRODUCT (GENERAL)

1.1 TECHNICAL SPECIFICATIONS

LED MODULE

Type	Model	Voltage	Operation Temperature	Weight (KG)	Dimensions 2 (mm)	Power (W)	IP
I	RGBW:12Wx7	AC100~240V 50/60Hz	-20~45	6.6	334x191x236	128	65

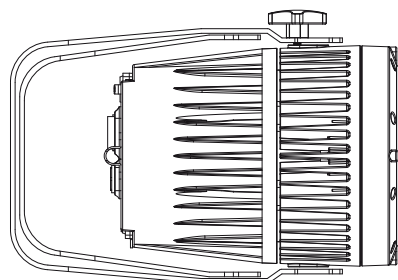
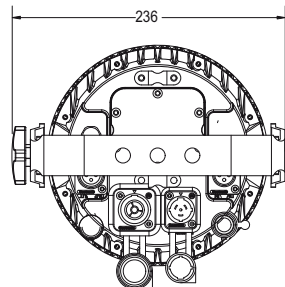
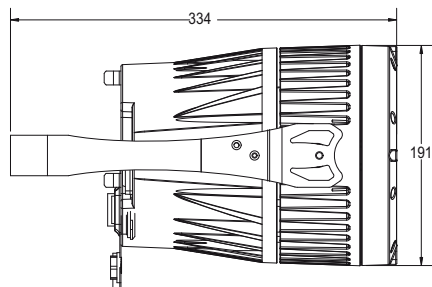

CHANNEL	VALUE	FUNCTION	
19	211 ↔ 215	WHITE3: 4200K	
	216 ↔ 220	WHITE4: 4900K	
	221 ↔ 225	WHITE5: 5600K	
	226 ↔ 230	WHITE6: 5900K	
	231 ↔ 235	WHITE7: 6500K	
	236 ↔ 240	WHITE8: 7200K	
	241 ↔ 245	WHITE9: 8000K	
	246 ↔ 250	WHITE10: 8500K	
	251 ↔ 255	WHITE11: 10000K	
	20	0 ↔ 9	STROBE NO FUNCTION
		10 ↔ 255	1~20Hz
21	0 ↔ 40	AUTO NO FUNCTION	
	41 ↔ 50	AUTO 1	
	51 ↔ 60	AUTO 2	
	61 ↔ 70	AUTO 3	
	71 ↔ 80	AUTO 4	
	81 ↔ 90	AUTO 5	
	91 ↔ 100	AUTO 6	
	101 ↔ 110	AUTO 7	
	111 ↔ 120	AUTO 8	
	121 ↔ 130	AUTO 9	
	131 ↔ 140	AUTO 10	
	141 ↔ 150	PR.01	
	151 ↔ 160	PR.02	
	161 ↔ 170	PR.03	
171 ↔ 180	PR.04		
181 ↔ 190	PR.05		
191 ↔ 200	PR.06		
201 ↔ 210	PR.07		
211 ↔ 220	PR.08		
221 ↔ 230	PR.09		
231 ↔ 255	PR.10		
22	0 ↔ 255	AUTO SPEED ADJUSTMENT When using CH13,AUTO01-AUTO10, this function activated	
23	0 ↔ 9	DIMMER SPEED PRESET DIMMER SPEED FROM DISPLAY MENU	
	10 ↔ 29	LINEAR DIMMER	
	30 ↔ 69	NON LINEAR DIMMER 1 (fastest)	
	70 ↔ 129	NON LINEAR DIMMER 2	
	130 ↔ 189	NON LINEAR DIMMER 3	
	190 ↔ 255	NON LINEAR DIMMER 4 (slowest)	
24	0 ↔ 255	ZOOM	
25	000 ↔ 200	NO FUNCTION	
	201 ↔ 220	ZOOM RESET	
	221 ↔ 255	NO FUNCTION	

FULL

CHANNEL	VALUE	FUNCTION
1	0 ↔ 255	MASTER DIMMER
2	0 ↔ 255	MASTER DIMMER FINE
3	0 ↔ 255	RED1
4	0 ↔ 255	RED FINE1
5	0 ↔ 255	GREEN1
6	0 ↔ 255	GREEN FINE1
7	0 ↔ 255	BLUE1
8	0 ↔ 255	BLUE FINE1
9	0 ↔ 255	WHITE1
10	0 ↔ 255	WHITE FINE1
11	0 ↔ 255	RED2
12	0 ↔ 255	RED FINE2
13	0 ↔ 255	GREEN2
14	0 ↔ 255	GREEN FINE2
15	0 ↔ 255	BLUE2
16	0 ↔ 255	BLUE FINE2
17	0 ↔ 255	WHITE2
18	0 ↔ 255	WHITE FINE2
19	0 ↔ 10	NO FUNCTION
	11 ↔ 30	RED100%/GREEN UP/BLUE0%
	31 ↔ 50	RED DOWN/GREEN 100%/BLUE0%
	51 ↔ 70	RED 0%/GREEN 100%/BLUE UP
	71 ↔ 90	RED 0%/GREEN DOWN/BLUE 100%
	91 ↔ 110	RED UP/GREEN 0%/BLUE100%
	111 ↔ 130	RED100%/GREEN 0%/BLU EDOWN
	131 ↔ 150	RED100%/GREEN UP/BLUE UP
	151 ↔ 170	RED DOWN/GREEN DOWN/BLUE 100%
	171 ↔ 200	RED100%/GREEN 100%P/BLUE100%/WHITE 100%
	201 ↔ 205	WHITE1: 3200K
206 ↔ 210	WHITE2: 3400K	

1.2 SAFETY WARNING

IMPORTANT:

- This product must be installed by a qualified professional.
- All maintenance must be carried out by a qualified electrician.
- A minimum distance of 0.5m must be maintained between the equipment and a combustible surface.
- The product must always be operated in a well ventilated area.
- DO NOT stare directly into the LED light source.
- Always disconnect the power before carrying out any maintenance.
- The earth must always be connected to the ground.
- Ensure that all parts of the equipment are kept clean and free of dust.

2 INSTALLATION

2.1 MOUNTING

HANGING

The fixture can be mounted in a hanging position using the supporting bracket. The bracket should be secured to the mounting truss or structure using a standard mounting clamp. Please note that when hanging the unit a safety cable should also be used.

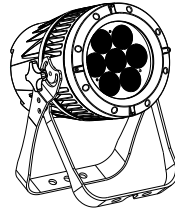

UPRIGHT

The fixture can be mounted in an upright or sitting position using the supporting brackets.

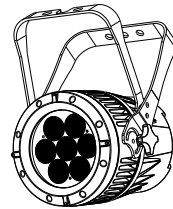

NOTE The LED MODULE can be mounted at any angle and in any position. It is possible to further adjust the angle of the LED MODULE using the two adjustment knobs located on the side of the fixture.

2.2 POWER CONNECTIONS

@ 220V: 12 units may be connected in series

@ 110V: 6 units may be connected in series

Note:

If the signal cable is over 60m between the DMX512 controller and fixture or between two fixtures, then a DMX signal amplifier is needed as well.

AR2.Z

CHANNEL	VALUE	FUNCTION
1	0 ↔ 255	MASTER DIMMER
2	0 ↔ 255	RED
3	0 ↔ 255	GREEN
4	0 ↔ 255	BLUE
5	0 ↔ 255	WHITE
6	0 ↔ 255	ZOOM
7	000 ↔ 200	NO FUNCTION
	201 ↔ 220	ZOOM RESET
	221 ↔ 255	NO FUNCTION

AR2.D

CHANNEL	VALUE	FUNCTION
1	0 ↔ 255	MASTER DIMMER
2	0 ↔ 255	RED
3	0 ↔ 255	GREEN
4	0 ↔ 255	BLUE
5	0 ↔ 255	WHITE

AR2.S

CHANNEL	VALUE	FUNCTION
1	0 ↔ 255	MASTER DIMMER
2	0 ↔ 255	RED
3	0 ↔ 255	GREEN
4	0 ↔ 255	BLUE
5	0 ↔ 255	WHITE
6	0 ↔ 255	STROBE

HSV

CHANNEL	VALUE	FUNCTION
1	0 ↔ 255	HUE(0~100%)
2	0 ↔ 255	SATURATION(0~100%)
3	0 ↔ 255	VALUE(0~100%)

3 DISPLAY PANEL OPERATION

3.1 DISPLAY OPERATION

- ◆ MENU: BACK;
- ◆ ENTER: ENTER OR SAVE;
- ◆ DOWN: DOWN;
- ◆ UP: UP;

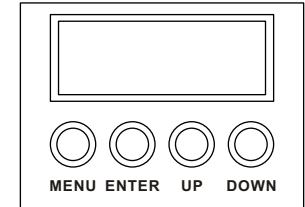

3.2 MENU MAP

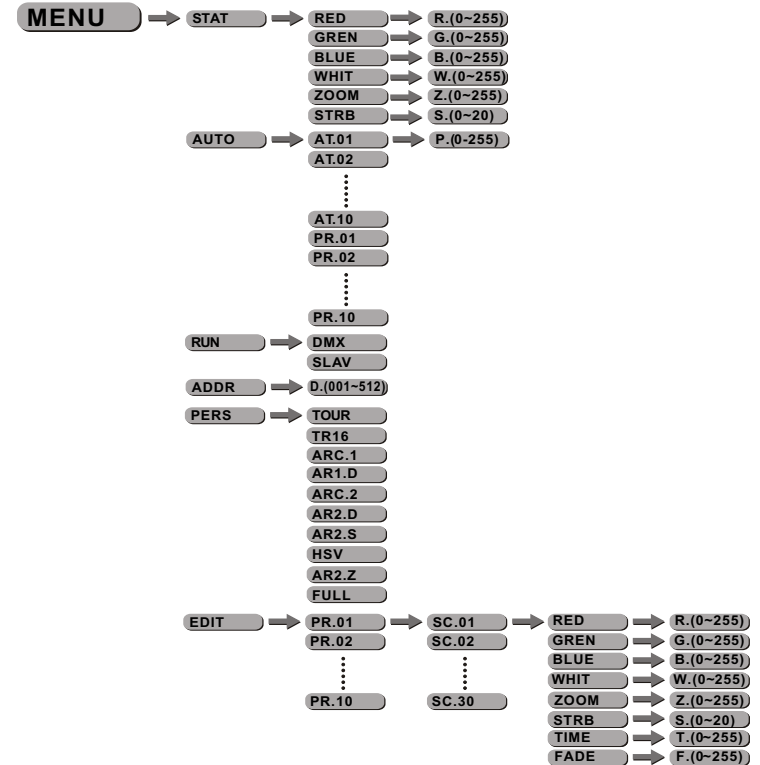

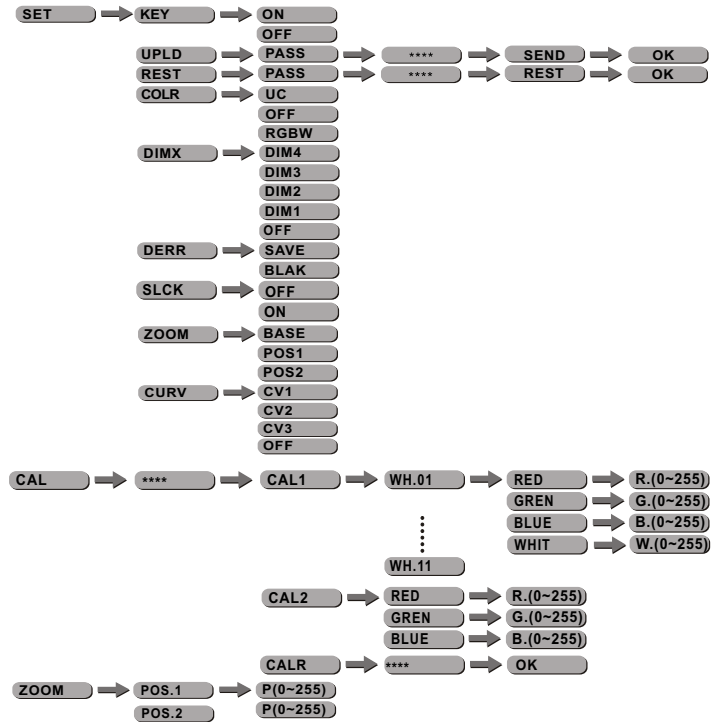

ARC.1

CHANNEL	VALUE	FUNCTION
1	0 ↔ 255	RED
2	0 ↔ 255	GREEN
3	0 ↔ 255	BLUE

AR1.D

CHANNEL	VALUE	FUNCTION
1	0 ↔ 255	MASTER DIMMER
2	0 ↔ 255	RED
3	0 ↔ 255	GREEN
4	0 ↔ 255	BLUE

ARC.2

CHANNEL	VALUE	FUNCTION
1	0 ↔ 255	RED
2	0 ↔ 255	GREEN
3	0 ↔ 255	BLUE
4	0 ↔ 255	WHITE

CHANNEL	VALUE	FUNCTION
12	0 ↔ 9	STROBE NO FUNCTION
	10 ↔ 255	1~20Hz
13	0 ↔ 40	AUTO NO FUNCTION
	41 ↔ 50	AUTO 1
	51 ↔ 60	AUTO 2
	61 ↔ 70	AUTO 3
	71 ↔ 80	AUTO 4
	81 ↔ 90	AUTO 5
	91 ↔ 100	AUTO 6
	101 ↔ 110	AUTO 7
	111 ↔ 120	AUTO 8
	121 ↔ 130	AUTO 9
	131 ↔ 140	AUTO 10
	141 ↔ 150	PR.01
	151 ↔ 160	PR.02
161 ↔ 170	PR.03	
171 ↔ 180	PR.04	
181 ↔ 190	PR.05	
191 ↔ 200	PR.06	
201 ↔ 210	PR.07	
211 ↔ 220	PR.08	
221 ↔ 230	PR.09	
231 ↔ 255	PR.10	
14	0 ↔ 255	AUTO SPEED ADJUSTMENT When using CH13,AUTO01-AUTO10, this function activated
15	0 ↔ 9	DIMMER SPEED PRESET DIMMER SPEED FROM DISPLAY MENU
	10 ↔ 29	LINEAR DIMMER
	30 ↔ 69	NON LINEAR DIMMER 1 (fastest)
	70 ↔ 129	NON LINEAR DIMMER 2
	130 ↔ 189	NON LINEAR DIMMER 3
	190 ↔ 255	NON LINEAR DIMMER 4 (slowest)
16	0 ↔ 255	ZOOM
17	000 ↔ 200	NO FUNCTION
	201 ↔ 220	ZOOM RESET
	221 ↔ 255	NO FUNCTION

3.21 EDIT STATIC COLOUR



- Combine **Red**, **Green**, **Blue**, **White** and **Zoom** to create an infinite range of colors (0-255)
- Set the value of the **Strobe** (0-20Hz)

3.22 ACTIVATING AUTO PROGRAMS

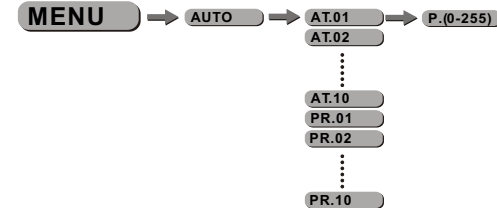

- Select the target **AUTO** program and press **ENTER**.
- Programs **AT.01** to **AT.10** are fully pre-programmed and will not be altered by changes in **EDIT** mode.
- Programs **PR.01** to **PR.10** are fully pre-programmed and can be edited in **EDIT** mode.

3.23 RUN MODE



- Enter the **RUN** mode to set working mode.
- **DMX** mode is for using the DMX512 controller to control the fixtures.
- **SLAV** mode is for Master -- Slave operation.

3.24 DMX512 SETTINGS



- Enter the **ADDR** mode to set the DMX ADDRESS.

3.25 PERSONALITY

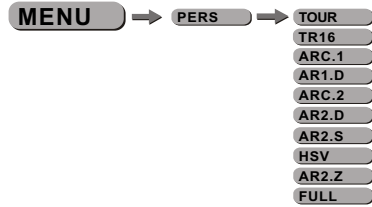

- Enter the **PERSONALITY** mode to select DMX mode: **TOUR** , **TR16** , **ARC.1** , **AR1.D** , **ARC.2** , **AR2.D** , **AR2.S** , **HSV** , **AR2.Z** , **FULL** .

3.26 EDITING CUSTOM PROGRAMS

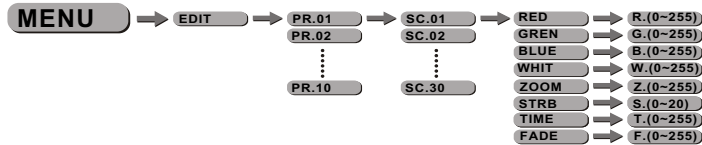

- Enter the **EDIT** mode to edit the custom programs **PR.01** to **PR.10** .
- Each custom program has 30 steps that can be edited.
- Each step allows the creation of a scene using **RED** **Red** , **GREEN** **Green** , **BLUE** **Blue** , **WHITE** **White** , **STRB** **Strb** , **TIME** **Time** & **FADE** **Fade** .

TR16

CHANNEL	VALUE	FUNCTION
1	0 ↔ 255	MASTER DIMMER
2	0 ↔ 255	MASTER DIMMER FINE
3	0 ↔ 255	RED
4	0 ↔ 255	RED FINE
5	0 ↔ 255	GREEN
6	0 ↔ 255	GREEN FINE
7	0 ↔ 255	BLUE
8	0 ↔ 255	BLUE FINE
9	0 ↔ 255	WHITE
10	0 ↔ 255	WHITE FINE
	0 ↔ 10	COLOR MACRO NO FUNCTION
	11 ↔ 30	RED100%/GREEN UP/BLUE0%
	31 ↔ 50	RED DOWN/GREEN 100%/BLUE0%
	51 ↔ 70	RED 0%/GREEN 100%/BLUE UP
	71 ↔ 90	RED 0%/GREEN DOWN/BLUE 100%
	91 ↔ 110	RED UP/GREEN 0%/BLUE100%
	111 ↔ 130	RED100%/GREEN 0%/BLU EDOWN
	131 ↔ 150	RED100%/GREEN UP/BLUE UP
11	151 ↔ 170	RED DOWN/GREEN DOWN/BLUE 100%
	171 ↔ 200	RED100%/GREEN 100%P/BLUE100%/WHITE 100%
	201 ↔ 205	WHITE1: 3200K
	206 ↔ 210	WHITE2: 3400K
	211 ↔ 215	WHITE3: 4200K
	216 ↔ 220	WHITE4: 4900K
	221 ↔ 225	WHITE5: 5600K
	226 ↔ 230	WHITE6: 5900K
	231 ↔ 235	WHITE 7: 6500K
	236 ↔ 240	WHITE 8: 7200K
	241 ↔ 245	WHITE 9: 8000K
	246 ↔ 250	WHITE 10: 8500K
	251 ↔ 255	WHITE 11: 10000K

CHANNEL	VALUE	FUNCTION
6	231↔235	WHITE 7: 6500K
	236↔240	WHITE 8: 7200K
	241↔245	WHITE 9: 8000K
	246↔250	WHITE 10: 8500K
	251↔255	WHITE 11: 10000K
7		STROBE
	0↔9	NO FUNCTION
	10↔255	1~20Hz
8		AUTO
	0↔40	NO FUNCTION
	41↔50	AUTO 1
	51↔60	AUTO 2
	61↔70	AUTO 3
	71↔80	AUTO 4
	81↔90	AUTO 5
	91↔100	AUTO 6
	101↔110	AUTO 7
	111↔120	AUTO 8
	121↔130	AUTO 9
	131↔140	AUTO 10
	141↔150	PR.01
	151↔160	PR.02
	161↔170	PR.03
	171↔180	PR.04
	181↔190	PR.05
	191↔200	PR.06
	201↔210	PR.07
	211↔220	PR.08
221↔230	PR.09	
231↔255	PR.10	
9		AUTO SPEED ADJUSTMENT
	0↔255	When using CH8,AUTO01-AUTO10, this function activated
10		DIMMER SPEED
	0↔9	PRESET DIMMER SPEED FROM DISPLAY MENU
	10↔29	LINEAR DIMMER
	30↔69	NON LINEAR DIMMER 1 (fastest)
	70↔129	NON LINEAR DIMMER 2
	130↔189	NON LINEAR DIMMER 3
190↔255	NON LINEAR DIMMER 4 (slowest)	
11	0↔255	ZOOM
12	000↔200	NO FUNCTION
	201↔220	ZOOM RESET
	221↔255	NO FUNCTION

3.27 SPECIAL SETTINGS

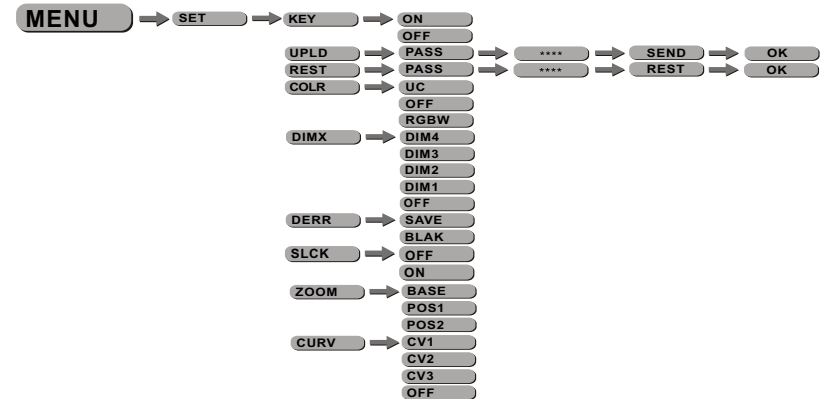

- [SET]...this menu allows the user to adjust key operation settings for this fixture.
- [KEY]...select [ON] for automatic lock-out. Password to re-enter the display is <UP> + <DOWN> + <UP> + <DOWN>.
- Select [UPLD] to upload the custom programs from the current MASTER unit to the SLAVE units.
- In order to reset custom modes to default values select [REST].
- [COLR] is for activate/unactivate the color calibration functions. When [RGBW] is selected, on RGB = 255,255,255, the color is displayed as calibrated in CAL2 --RGBW. When [COLR] is set [OFF], on RGB = 255,255,255, the RGB values are not adjusted and the output is most powerful. When [UC] is selected, the RGB output are adjusted to a standard preset universal color which balances fixtures from different generations.
- Select [DIM1], [DIM2], [DIM3] or [DIM4] for different dimming speeds. ([DIM4] is the slowest dimming speed)
- [DERR] Choose [Save] in order to save the last DMX data in case of DMX signal error. Choose [Black] in order to blackout in case of DMX signal error.
- [SLCK] is used to lock the settings menu. When [SLCK] is set to [ON] then user must insert passcode (UP+DOWN+UP+DOWN) in order to access the settings menu.
- [ZOOM] Calibrate the position of POS1&POS2. Set position as 0 for smallest zoom position. select BASE for default zoom position (zoom=0)
- [CURV] allows the user to adjust the shape of the dimming curve. See the CURV chart to understand more about actual dimming curves.

3.28 BALANCE PARAMETERS AND CORRECTION MENU DISPLAY

Press **MENU** button to enter the password confirmation, to enter the correct password <UP + DOWN + UP + DOWN > Key, press the **MENU** in, the correct password will enter show submenu

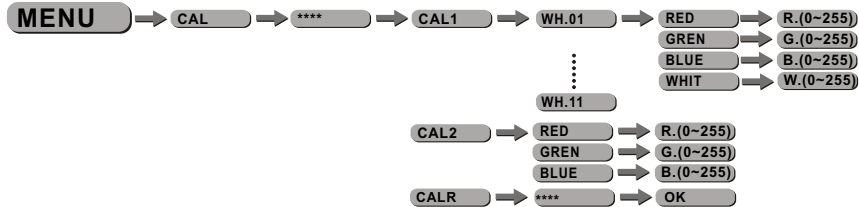

- Enter the **CAL1** to select white color of different color temperature.
- There are 11 pre-programmed White colors can be edited by using **Red** , **Green** , **Blue** & **White** .
- Enter the **CAL2** to adjust the RGB parameter to make different whites.
- When the new setting is activated, the DMX controller choose RGB = 255,255,255 the white color will be made by the actual RGB values on the **CAL2** .

3.29 ZOOM RANGE



- Select the **ZOOM** range. **POS1** & **POS2** set the small position for the zoom function. Note that when using DMX to control the fixture, the user will only be able to access upto the set ZOOM position. It is not possible to adjust beyond the set position.

4 USING A DMX512 CONTROLLER

4.1 CHANNEL ASSIGNMENT

- Note: This product have three DMX512 channel configuration: **TOUR** , **TR16** , **ARC.1** , **AR1.D** , **ARC.2** , **AR2.D** , **AR2.S** , **HSV** , **AR2.Z** and **FULL**

TOUR

CHANNEL	VALUE	FUNCTION
1	0 ↔ 255	MASTER DIMMER
2	0 ↔ 255	RED (or STEP TIME when CUS.01-CUS.10 in CH8 is activated)
3	0 ↔ 255	GREEN (or FADE TIME when CUS.01-CUS.10 in CH8 is activated)
4	0 ↔ 255	BLUE
5	0 ↔ 255	WHITE
		COLOR MACRO
	0 ↔ 10	NO FUNCTION
	11 ↔ 30	RED 100%/GREEN UP/BLUE 0%
	31 ↔ 50	RED DOWN/GREEN 100%/BLUE 0%
	51 ↔ 70	RED 0%/GREEN 100%/BLUE UP
	71 ↔ 90	RED 0%/GREEN DOWN/BLUE 100%
	91 ↔ 110	RED UP/GREEN 0%/BLUE 100%
	111 ↔ 130	RED 100%/GREEN 0%/BLUE DOWN
	131 ↔ 150	RED 100%/GREEN UP/BLUE UP
6	151 ↔ 170	RED DOWN/GREEN DOWN/BLUE 100%
	171 ↔ 200	RED 100%/GREEN 100%/BLUE 100%/WHITE 100%
	201 ↔ 205	WHITE 1: 3200K
	206 ↔ 210	WHITE 2: 3400K
	211 ↔ 215	WHITE 3: 4200K
	216 ↔ 220	WHITE 4: 4900K
	221 ↔ 225	WHITE 5: 5600K
	226 ↔ 230	WHITE 6: 5900K