

# RAYTHEON

## USER MANUAL

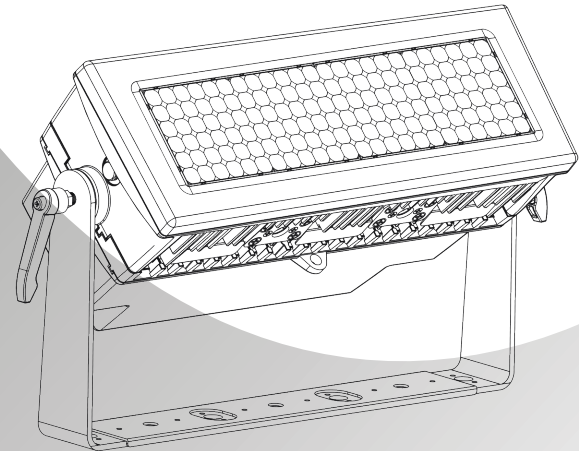

SS353

MODELS: SS353XCEM

 **SILVER STAR**  
Professional Lighting

[www.yajiang.cn](http://www.yajiang.cn)

RD-SS353-SM-00(SS-I)

# 1 PRODUCT SPECIFICATIONS

## 1.1 PRODUCT SPECIFICATIONS

- ◆ Voltage: AC100~240V, 50/60Hz
- ◆ Max Power: 1100W
- ◆ Operation Temperature: -20°C~45°C
- ◆ Size: 585×189×307.5mm
- ◆ IP65
- ◆ Weight: 10.5kg

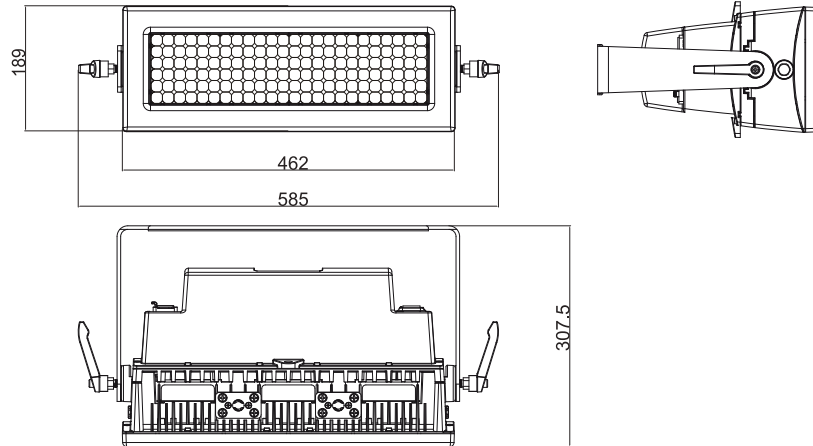

41	103.9	127	325.0	213	548.4
42	106.4	128	327.5	214	551.0
43	108.9	129	330.1	215	553.5
44	111.4	130	332.6	216	556.1
45	113.9	131	335.2	217	558.6
46	116.7	132	337.7	218	561.2
47	119.3	133	340.3	219	563.7
48	121.8	134	342.7	220	566.3
49	124.4	135	345.2	221	568.8
50	126.9	136	347.8	222	571.4
51	129.5	137	350.3	223	573.3
52	132.0	138	352.9	224	576.8
53	134.6	139	355.4	225	578.9
54	137.1	140	358.0	226	581.9
55	139.6	141	360.5	227	584.7
56	142.1	142	363.1	228	587.5
57	144.7	143	365.6	229	590.3
58	147.2	144	368.1	230	593.1
59	149.8	145	370.7	231	595.9
60	152.3	146	373.2	232	598.7
61	154.9	147	375.7	233	601.5
62	157.4	148	378.3	234	604.3
63	160.0	149	380.8	235	607.1
64	162.5	150	383.3	236	609.9
65	165.0	151	385.9	237	612.7
66	167.5	152	388.4	238	615.5
67	170.0	153	391.3	239	618.3
68	172.5	154	393.5	240	621.1
69	175.0	155	396.2	241	623.9
70	177.5	156	398.7	242	626.7
71	180.0	157	401.3	243	629.5
72	182.5	158	403.8	244	632.3
73	185.3	159	406.4	245	635.1
74	187.8	160	408.9	246	637.9
75	190.4	161	411.5	247	640.7
76	192.9	162	414.0	248	643.5
77	195.5	163	416.6	249	646.3
78	198.0	164	419.1	250	646.0
79	200.6	165	421.7	251	650.0
80	203.1	166	424.2	252	650.0
81	205.7	167	426.8	253	650.0
82	208.2	168	429.3	254	650.0
83	210.7	169	431.9	255	650.0
84	213.2	170	434.4		
85	215.7	171	437.0		

## Duration

DMX	Duration ms	DMX	Duration ms	DMX	Duration ms
0	x	86	218.3	172	444.3
1	14.0	87	220.8	173	446.8
2	14.5	88	223.4	174	449.4
3	15.0	89	225.9	175	451.9
4	15.5	90	228.5	176	454.5
5	16.0	91	231.0	177	457.0
6	17.0	92	233.6	178	459.6
7	17.7	93	236.1	179	462.1
8	20.3	94	238.6	180	464.7
9	22.8	95	241.2	181	467.2
10	25.3	96	243.7	182	469.8
11	27.9	97	246.3	183	472.3
12	30.4	98	248.8	184	474.9
13	33.0	99	251.4	185	477.4
14	35.5	100	253.9	186	480.0
15	38.0	101	256.5	187	482.5
16	40.6	102	259.0	188	485.1
17	43.1	103	261.6	189	487.6
18	45.7	104	264.0	190	490.2
19	48.2	105	266.6	191	492.7
20	50.7	106	269.1	192	495.3
21	53.3	107	271.7	193	497.8
22	55.8	108	274.2	194	500.4
23	58.3	109	276.8	195	502.9
24	60.9	110	279.3	196	505.5
25	63.4	111	281.9	197	508.0
26	66.0	112	284.4	198	510.6
27	68.5	113	287.0	199	513.1
28	71.1	114	291.9	200	515.7
29	73.6	115	294.5	201	518.2
30	76.2	116	297.2	202	520.8
31	78.7	117	299.8	203	523.3
32	81.3	118	302.5	204	525.9
33	83.8	119	305.1	205	528.4
34	86.4	120	307.8	206	531.0
35	88.9	121	310.4	207	533.5
36	91.4	122	313.1	208	535.7
37	93.9	123	315.7	209	538.2
38	96.4	124	317.3	210	540.8
39	98.9	125	319.9	211	543.3
40	101.4	126	322.4	212	545.9

## 1.2 SAFETY WARNING

### IMPORTANT:

- This product must be installed by a qualified professional.
- All maintenance must be carried out by a qualified electrician.
- A minimum distance of 0.5m must be maintained between the equipment and a combustible surface.
- The product must always be operated in a well ventilated area.
- DO NOT stare directly into the LED light source.
- Always disconnect the power before carrying out any maintenance.
- The earth must always be connected to the ground.
- Ensure that all parts of the equipment are kept clean and free of dust.

## 2 INSTALLATION

### 2.1 MOUNTING:

- The fixture can be mounted in any position.
- Always ensure that mounting surface can withstand 10 times the weight of the fixture.
- Always use a safety cable when mounting the fixture in any elevated position.

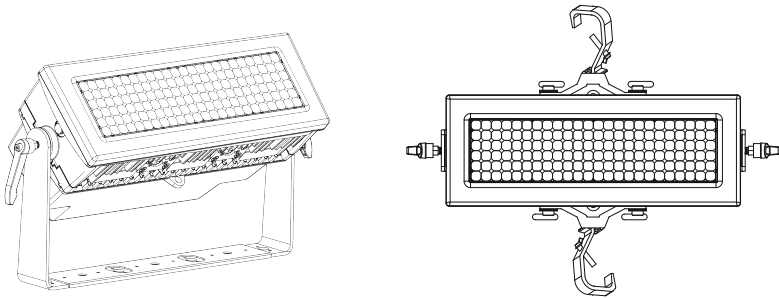

#### **IMPORTANT SAFETY NOTE!!**

Always use a safety cable when installing this unit!!  
Be sure that the safety cable is connected to a solid load-bearing structure.

### 2.2 POWER CONNECTIONS

**Note:**

If the signal cable is over 60m between the DMX512 controller and fixture or between two fixtures, then a DMX signal amplifier is needed as well.

41	384.0	127	120.0	213	69.0
42	376.0	128	119.0	214	68.7
43	360.0	129	118.0	215	68.4
44	350.0	130	117.0	216	68.1
45	336.0	131	116.0	217	67.8
46	330.0	132	115.0	218	67.5
47	320.0	133	114.0	219	67.2
48	315.0	134	113.0	220	66.9
49	310.0	135	112.0	221	66.6
50	305.0	136	111.0	222	66.3
51	300.0	137	110.0	223	66.0
52	290.0	138	109.0	224	65.7
53	284.0	139	110.0	225	65.4
54	280.0	140	109.5	226	65.1
55	275.0	141	109.0	227	64.8
56	270.0	142	108.5	228	64.5
57	264.0	143	108.0	229	64.2
58	255.0	144	107.5	230	63.9
59	250.0	145	107.0	231	63.6
60	245.0	146	106.5	232	63.3
61	240.0	147	106.0	233	63.0
62	237.0	148	105.5	234	62.7
63	234.0	149	105.0	235	62.4
64	231.0	150	104.5	236	62.1
65	227.0	151	104.0	237	61.8
66	224.0	152	103.0	238	61.5
67	220.0	153	102.0	239	61.2
68	217.0	154	101.0	240	60.9
69	214.0	155	100.0	241	60.6
70	211.0	156	99.0	242	60.3
71	208.0	157	98.0	243	60.0
72	205.0	158	97.0	244	59.0
73	200.0	159	96.0	245	58.0
74	197.0	160	95.0	246	57.0
75	195.0	161	94.0	247	56.0
76	192.0	162	93.0	248	55.0
77	190.0	163	92.0	249	40.0
78	187.0	164	91.0	250	40.0
79	185.0	165	90.0	251	40.0
80	182.0	166	89.5	252	40.0
81	180.0	167	89.0	253	40.0
82	178.0	168	88.5	254	40.0
83	176.0	169	88.0	255	40.0
84	174.0	170	87.5		
85	172.0	171	87.0		

### Period (Rate time)

DMX	Period(Rate time)ms	DMX	Period(Rate time)ms	DMX	Period(Rate time)ms
0	x	86	170.0	172	86.5
1	x	87	168.0	173	86.0
2	x	88	166.0	174	85.5
3	x	89	164.0	175	85.0
4	x	90	162.0	176	84.5
5	x	91	160.0	177	84.0
6	x	92	158.0	178	83.5
7	x	93	156.0	179	83.0
8	x	94	154.0	180	82.5
9	x	95	152.0	181	82.0
10	2320.0	96	151.0	182	81.5
11	1760.0	97	150.0	183	81.0
12	1760.0	98	149.0	184	80.5
13	1400.0	99	148.0	185	80.0
14	1400.0	100	147.0	186	79.6
15	1160.0	101	146.0	187	79.2
16	1160.0	102	145.0	188	78.8
17	1000.0	103	144.0	189	78.4
18	1000.0	104	143.0	190	78.0
19	880.0	105	142.0	191	77.6
20	880.0	106	141.0	192	77.2
21	760.0	107	140.0	193	76.8
22	740.0	108	139.0	194	76.4
23	720.0	109	138.0	195	76.0
24	700.0	110	137.0	196	75.6
25	640.0	111	136.0	197	75.2
26	600.0	112	135.0	198	74.8
27	580.0	113	134.0	199	74.4
28	570.0	114	133.0	200	74.0
29	560.0	115	132.0	201	73.6
30	540.0	116	131.0	202	73.2
31	500.0	117	130.0	203	72.8
32	490.0	118	129.0	204	72.4
33	480.0	119	128.0	205	72.0
34	460.0	120	127.0	206	71.6
35	440.0	121	126.0	207	71.2
36	430.0	122	125.0	208	70.8
37	420.0	123	124.0	209	70.4
38	410.0	124	123.0	210	70.0
39	400.0	125	122.0	211	69.6
40	390.0	126	121.0	212	69.2

## 3 DISPLAY PANEL OPERATION

### 3.1 DISPLAY OPERATION

- ◆ MENU: BACK;
- ◆ ENTER: ENTER OR SAVE;
- ◆ DOWN: DOWN;
- ◆ UP: UP;

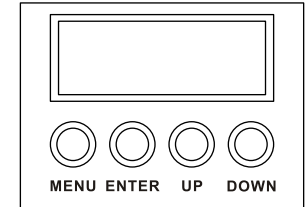

### 3.2 MENU MAP

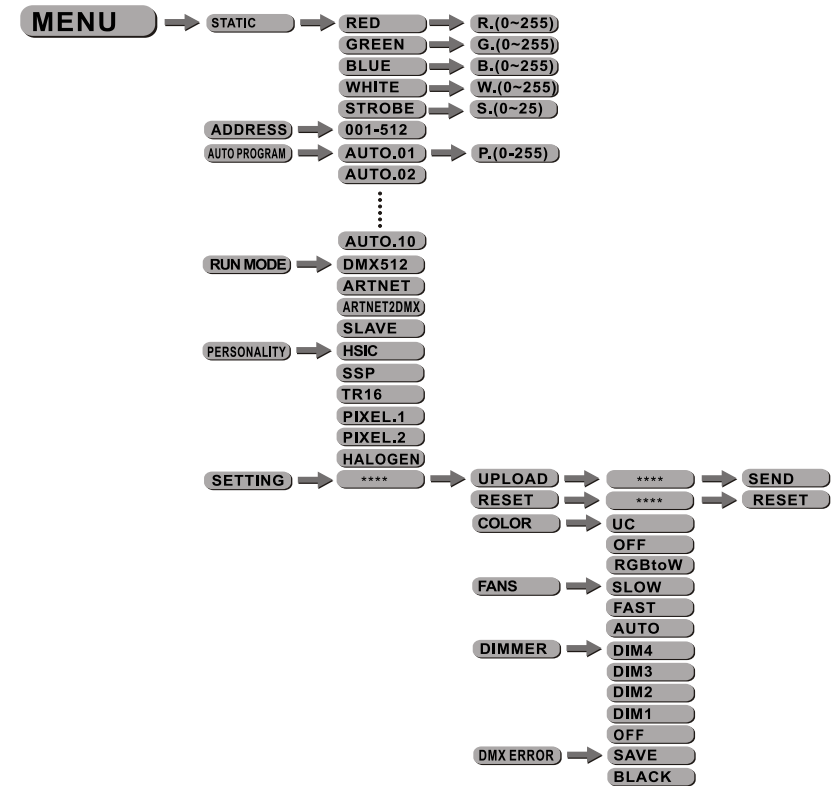

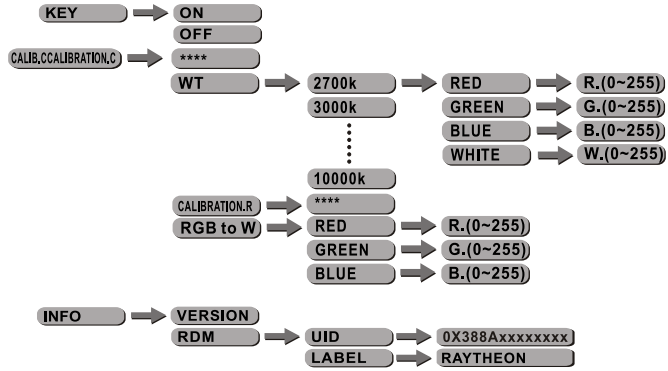
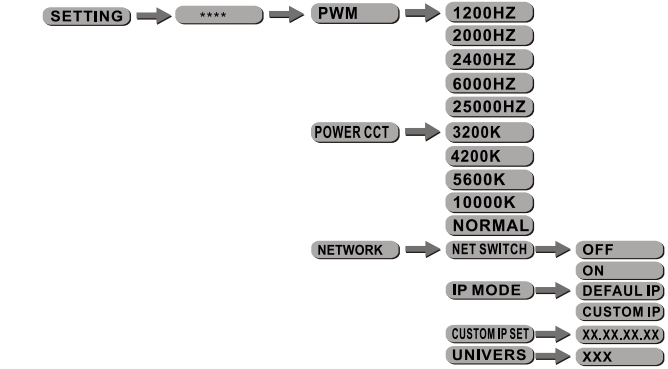

### HALOGEN

CHANNEL	VALUE	FUNCTION
1	0 ↔ 255	DIMMER
2	0 ↔ 255	Halogen effect (ON-OFF)
3	0 ↔ 9	STROBE1 NO FUNCTION
	10 ↔ 255	0-25Hz
4	0 ↔ 255	Duration ( 14ms-650ms )
5	0 ↔ 9	STROBE2 NO FUNCTION
	10 ↔ 109	LIGHTNING STROBE
	110 ↔ 119	NO FUNCTION
	120 ↔ 255	RANDOM SROBE

### ◆ Instruction for strobe effect

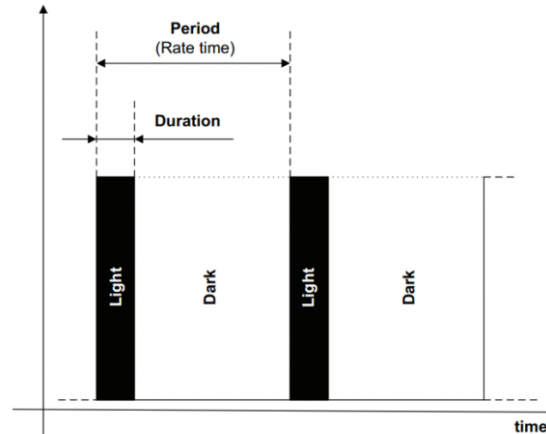

When Duration is shorter than Period , then has darkness time , able to strobe.  
 When Duration is longer than Period , then fixture will lit on always , no strobe effect .  
 Period range : 2320ms---40ms . Duration range : 14ms-650ms

## PIXEL.2

CHANNEL	VALUE	FUNCTION
34	0 ↔ 255	GREEN8
35	0 ↔ 255	BLUE8
36	0 ↔ 255	WHITE8
37	0 ↔ 255	RED9
38	0 ↔ 255	GREEN9
39	0 ↔ 255	BLUE9
40	0 ↔ 255	WHITE9
41	0 ↔ 255	RED10
42	0 ↔ 255	GREEN10
43	0 ↔ 255	BLUE10
44	0 ↔ 255	WHITE10
45	0 ↔ 255	RED11
46	0 ↔ 255	GREEN11
47	0 ↔ 255	BLUE11
48	0 ↔ 255	WHITE11
49	0 ↔ 255	RED12
50	0 ↔ 255	GREEN12
51	0 ↔ 255	BLUE12
52	0 ↔ 255	WHITE12

Below is the distribution of Zone 1 Zone 12

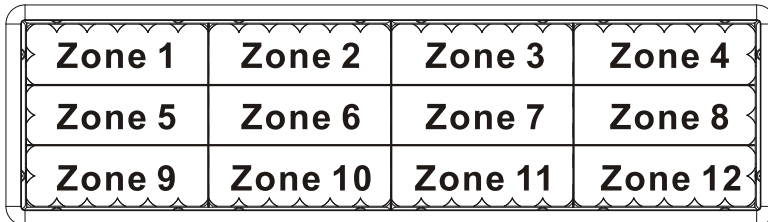

### 3.3 EDIT STATIC COLOUR

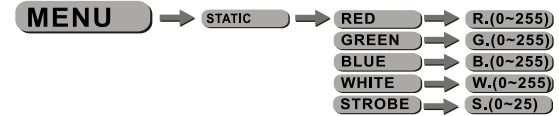

- Combine **【RED】** , **【GREEN】** , **【BLUE】** AND **【WHITE】** to create an infinite range of colors (0-255)
- Set the value of the **【STROBE】** (0-25Hz)

### 3.4 DMX512 SETTINGS



- Enter the **【 ADDRESS】** mode to set the DMX ADDRESS.

### 3.5 ACTIVATING AUTO PROGRAMS

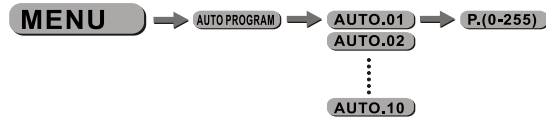

- Select the target **【AUTO PROGRAM】** program and press **【ENTER】** .
- Programs **【AUTO.01】** to **【AUTO.10】** are fully pre-programmed and will not be altered by changes in **【EDIT】** mode.

### 3.6 RUN MODE



- Enter the **【 RUN MODE】** mode to set working mode.
- **【 DMX】** mode is for using the DMX512 controller to control the fixtures.
- **【 SLAVE】** mode is for Master -- Slave operation.
- **【 ARTNET】** accept ARTNET control
- **【 ARTNET2DMX】** Fixture can accept ARTNET control , and output from DMX XLR **【 ARTNET2DMX】** mode is able to connect maximum 10pc fixtures

### 3.7 PERSONALITY

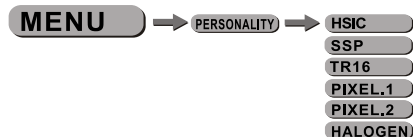

- Enter the **PERSONALITY** mode to select DMX mode: **HSIC** , **SSP** , **TR16** , **LIXEL.1** , **LIXEL.2** , **HALOGEN**

#### Introduction for HSIC

- **HUE**: colorful present(red, orange,yellow, green,cyan, blue, magentacolor changeable)
- **HUE FINE**: fine dimming when choose a color
- **SATURATION**: adjust saturation when choose a color
- **INTENSITY**: adjust intensity for chosen color
- **CCT**: choose needed color temperature(2700k, 3000k, 3200k, 3500k, 4000k, 4200k, 4500k, 5600k, 6000k, 6500k, 7200k, 8000k)

### 3.8 SPECIAL SETTINGS

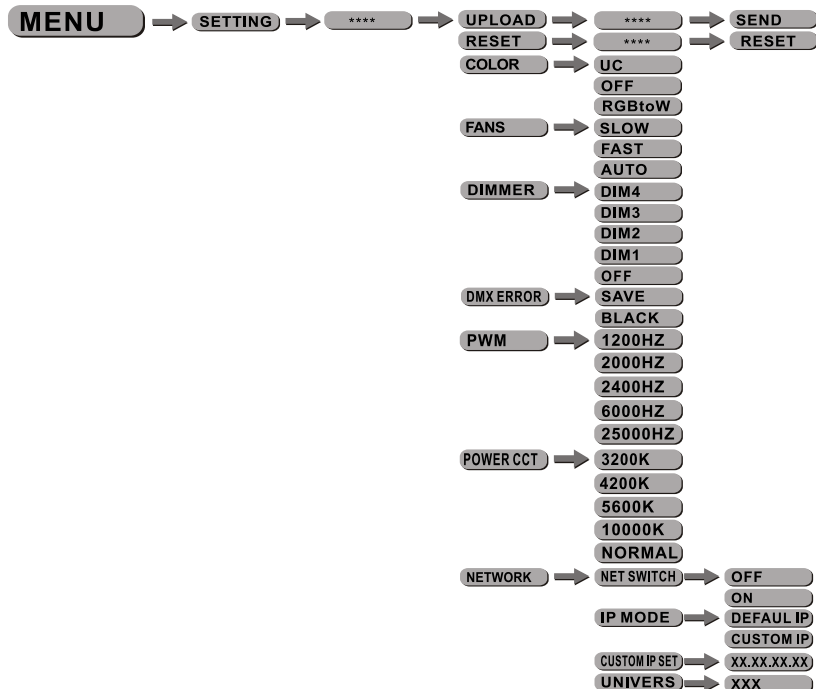

### PIXEL.2

CHANNEL	VALUE	FUNCTION
1	0 ↔ 255	MASTER DIMMER
2		STROBE1
	0 ↔ 9	NO FUNCTION
3	10 ↔ 255	0-25Hz
	0 ↔ 255	Duration ( 14ms-650ms)
4		STROBE2
	0 ↔ 9	NO FUNCTION
	10 ↔ 109	LIGHTNING STROBE
	110 ↔ 119	NO FUNCTION
4	120 ↔ 255	RANDOM SROBE
5	0 ↔ 255	RED1
6	0 ↔ 255	GREEN1
7	0 ↔ 255	BLUE1
8	0 ↔ 255	WHITE1
9	0 ↔ 255	RED2
10	0 ↔ 255	GREEN2
11	0 ↔ 255	BLUE2
12	0 ↔ 255	WHITE2
13	0 ↔ 255	RED3
14	0 ↔ 255	GREEN3
15	0 ↔ 255	BLUE3
16	0 ↔ 255	WHITE3
17	0 ↔ 255	RED4
18	0 ↔ 255	GREEN4
19	0 ↔ 255	BLUE4
20	0 ↔ 255	WHITE4
21	0 ↔ 255	RED5
22	0 ↔ 255	GREEN5
23	0 ↔ 255	BLUE5
24	0 ↔ 255	WHITE5
25	0 ↔ 255	RED6
26	0 ↔ 255	GREEN6
27	0 ↔ 255	BLUE6
28	0 ↔ 255	WHITE6
29	0 ↔ 255	RED7
30	0 ↔ 255	GREEN7
31	0 ↔ 255	BLUE7
32	0 ↔ 255	WHITE7
33	0 ↔ 255	RED8



## PIXEL.1

CHANNEL	VALUE	FUNCTION
34	0 ↔ 255	BLUE10
35	0 ↔ 255	RED11
36	0 ↔ 255	GREEN11
37	0 ↔ 255	BLUE11
38	0 ↔ 255	RED12
39	0 ↔ 255	GREEN12
40	0 ↔ 255	BLUE12

Below is the distribution of Zone 1 Zone 12

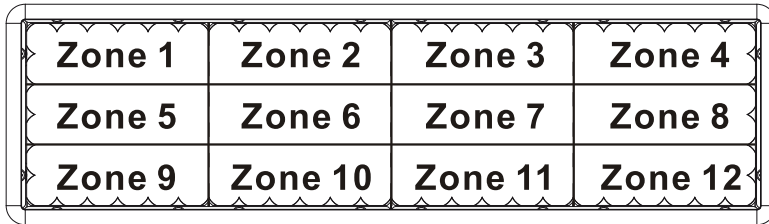

- [SETTING]...this menu allows the user to adjust key operation settings for this fixture.
- Select [UPLOAD] to upload the custom programs from the current MASTER unit to the SLAVE units.
- In order to reset custom modes to default values select [RESET] .  
Note: [UC][RGBW][CALIB.C] can't reset
- [COLOR] is for activate/unactivate the color calibration functions. When [RGBW] is selected, on RGB = 255,255,255, the color is displayed as calibrated in CALIB.C -- RGBW. When [COLOR] is set [OFF] , on RGB = 255,255,255, the RGB values are not adjusted and the output is most powerful. When [UC] is selected, the RGB output are adjusted to a standard preset universal color which balances fixtures from different generations.  
Note: [COLOR] work only when choose [NORMAL] at [FULL POWER CCT]
- [FANS] menu, select [SLOW/FAST/AUTO] as required fan speed.
- Select [DIM1], [DIM2], [DIM3] or [DIM4] for different dimming speeds. ([DIM4] is the slowest dimming speed)
- [DMX ERROR] Choose [SAVE] in order to save the last DMX data in case of DMX signal error. Choose [BLACK] in order to blackout in case of DMX signal error.
- <PWM\_RATE> is PWM refresh rate bottom, press UP/DOWN to choose <1200Hz>, <2000Hz>, <4000Hz>, <6000Hz>, <25000Hz>  
Note: with refresh rate increased, gray rate of dimmer will be reduced, (that's means high refresh rate, low gray rate), when it's <4000Hz>, CV3 is invalid, when it's <25000Hz>, CV1 CV2 CV3 are invalid, so please lower PWM rate to increase gray rate in necessary.
- <FULL POWER CCT> is the color temperature choose bottom, press UP/DOWN to choose, under full power, <3200K>, <4200K>, <5600K>, <10000K> can be chosen, when choose <COLOR>, <3200K>, <4200K>, <5600K>, <10000K> are not work, but choose <NORMAL>.
- 【NET SWITCH】 is net switch, OFF adhere to 2.XX.XX.XX, ON adhere to 2.XX.XX.XX, 【IP MODE】 is IP mode setting, "DEFAULT IP" is default IP, CUSTOM IP is user IP, 【CUSTOM IP SET】 is customer IP setting, 【UNIVERS】 is data bulk setting, output series 0-255
- Net wire: Straight-through cable is recommended between T568B wire order, the computer connected to the switch with a straight-through cable, the connection between the switch and the lamp used T568A line order with a straight-through cable crossover cable at one end and the other end with T568B wire order. Lamps directly connected computer should use a crossover cable

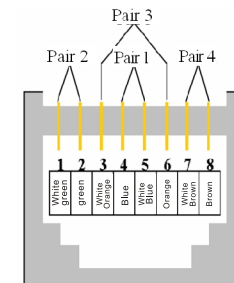

T568A Line sequence

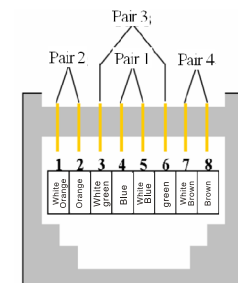

T568B Line sequence

### 3.9 ACTIVATE THE PASSWORD



- Enter the **【KEY】** mode to select whether the access password is on or off.
- When the fixture is set as PASS **【ON】** , after 30 seconds or turn on the fixture next time, the fixture will need an access password to enter the display menu control.

**Note:** The factory access password is **【UP】 + 【DOWN】 + 【UP】 + 【DOWN】** , then press **【ENTER】** to confirm the access.

### 3.10 BALANCE PARAMETERS AND CORRECTION MENU DISPLAY

Press **【MENU】** button to enter the password confirmation, to enter the correct password < UP + DOWN + UP + DOWN >

Key, press the **【MENU】** in, the correct password will enter show submenu

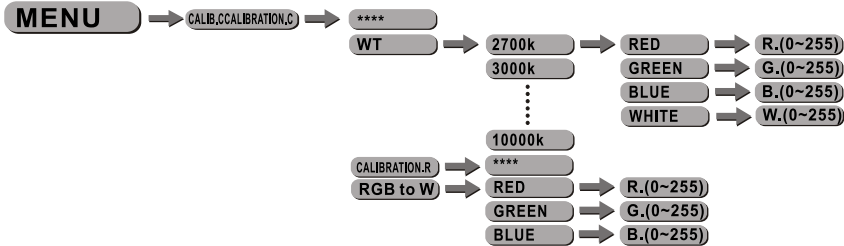

- Enter the **【CALIB.CCALIBRATION.C】** to select white color of different color temperature.
- There are 12 pre-programmed White colors can be edited by using **【RED】** , **【GREEN】** , **【BLUE】** & **【WHITE】** .  
Note: if CCT data is changed in **【WHITE】** from 2700k to 10000k, CCT of according channel will be changed also
- Enter the **【RGBtoW】** to adjust the RGB parameter to make different whites.
- When the new setting is activated, the DMX controller choose RGB = 255,255,255 the white color will be made by the actual RGB values on the **【RGBW】** .

### 3.11 INFO



- Press **【ENTER】** and go to **【INFO】** ,you can check **【VERSION】** , press **【DOWN】** / **【UP】** to check **【RDM】** , **【LABEL】** , press **【MENU】** and back.

### PIXEL.1

CHANNEL	VALUE	FUNCTION
1	0 ↔ 255	MASTER DIMMER
2		STROBE1
	0 ↔ 9	NO FUNCTION
3	10 ↔ 255	0-25Hz
	0 ↔ 255	Duration ( 14ms-650ms)
4		STROBE2
	0 ↔ 9	NO FUNCTION
	10 ↔ 109	LIGHTNING STROBE
	110 ↔ 119	NO FUNCTION
5	120 ↔ 255	RANDOM SROBE
	0 ↔ 255	RED1
6	0 ↔ 255	GREEN1
7	0 ↔ 255	BLUE1
8	0 ↔ 255	RED2
9	0 ↔ 255	GREEN2
10	0 ↔ 255	BLUE2
11	0 ↔ 255	RED3
12	0 ↔ 255	GREEN3
13	0 ↔ 255	BLUE3
14	0 ↔ 255	RED4
15	0 ↔ 255	GREEN4
16	0 ↔ 255	BLUE4
17	0 ↔ 255	RED5
18	0 ↔ 255	GREEN5
19	0 ↔ 255	BLUE5
20	0 ↔ 255	RED6
21	0 ↔ 255	GREEN6
22	0 ↔ 255	BLUE6
23	0 ↔ 255	RED7
24	0 ↔ 255	GREEN7
25	0 ↔ 255	BLUE7
26	0 ↔ 255	RED8
27	0 ↔ 255	GREEN8
28	0 ↔ 255	BLUE8
29	0 ↔ 255	RED9
30	0 ↔ 255	GREEN9
31	0 ↔ 255	BLUE9
32	0 ↔ 255	RED10
33	0 ↔ 255	GREEN10

CHANNEL	VALUE	FUNCTION
14		STROBE2
	0 ↔ 9	NO FUNCTION
	10 ↔ 109	LIGHTNING STROBE
	110 ↔ 119	NO FUNCTION
	120 ↔ 255	RANDOM SROBE
15		AUTO
	0 ↔ 9	NO FUNCTION
	10 ↔ 30	AUTO 01
	31 ↔ 50	AUTO 02
	51 ↔ 70	AUTO 03
	71 ↔ 90	AUTO 04
	91 ↔ 110	AUTO 05
	111 ↔ 130	AUTO 06
	131 ↔ 150	AUTO 07
	151 ↔ 170	AUTO 08
171 ↔ 190	AUTO 09	
191 ↔ 255	AUTO 10	
16	0 ↔ 255	AUTO SPEED ADJUSTMENT
17		DIMMER SPEED
	0 ↔ 9	NO FUNCTION
	10 ↔ 29	OFF
	30 ↔ 69	DIM1
	70 ↔ 129	DIM2
	130 ↔ 189	DIM3
	190 ↔ 255	DIM4

## 4 USING A DMX512 CONTROLLER

### 4.1 CHANNEL ASSIGNMENT

- Note: This product have four DMX512 channel configuration:  
**【HSIC】**, **【SSP】**, **【TR16】**, **【PIXEL.1】**, **【PIXEL.2】**, **【HALOGEN】**.

HSIC		
CHANNEL	VALUE	FUNCTION
1	0 ↔ 255	INTENSITY
2	0 ↔ 255	HUE
3	0 ↔ 255	HUE FINE
4	0 ↔ 255	SATURATION
5		CCT
	0 ↔ 10	NO FUNCTION
	11 ↔ 30	2700K
	31 ↔ 50	3000K
	51 ↔ 70	3200K
	71 ↔ 90	3500K
	91 ↔ 110	4000K
	111 ↔ 130	4200K
	131 ↔ 150	4500K
	151 ↔ 170	5600K
171 ↔ 190	6000K	
191 ↔ 210	6500K	
211 ↔ 230	7200K	
231 ↔ 255	8000K	
6		STROBE1
	0 ↔ 9	NO FUNCTION
	10 ↔ 255	0-25Hz
7	0 ↔ 255	Duration ( 14ms-650ms)
8		STROBE2
	0 ↔ 9	NO FUNCTION
	10 ↔ 109	LIGHTNING STROBE
	110 ↔ 119	NO FUNCTION
	120 ↔ 255	RANDOM SROBE
9		DIMMER SPEED
	0 ↔ 9	NO FUNCTION
	10 ↔ 29	OFF
	30 ↔ 69	DIM1
	70 ↔ 129	DIM2
	130 ↔ 189	DIM3
	190 ↔ 255	DIM4

SSP		
CHANNEL	VALUE	FUNCTION
1	0 ↔ 255	MASTER DIMMER
2	0 ↔ 255	RED
3	0 ↔ 255	GREEN
4	0 ↔ 255	BLUE
5	0 ↔ 255	WHITE
6		STROBE1
	0 ↔ 9	NO FUNCTION
	10 ↔ 255	0-25Hz
7	0 ↔ 255	Duration ( 14ms-650ms )
8		STROBE2
	0 ↔ 9	NO FUNCTION
	10 ↔ 109	LIGHTNING STROBE
	110 ↔ 119	NO FUNCTION
	120 ↔ 255	RANDOM SROBE

TR16		
CHANNEL	VALUE	FUNCTION
1	0 ↔ 255	MASTER DIMMER
2	0 ↔ 255	MASTER DIMMER FINE
3	0 ↔ 255	RED
4	0 ↔ 255	RED FINE
5	0 ↔ 255	GREEN
6	0 ↔ 255	GREEN FINE
7	0 ↔ 255	BLUE
8	0 ↔ 255	BLUE FINE
9	0 ↔ 255	WHITE
10	0 ↔ 255	WHITE FINE
11		COLOR MARCOS
	0 ↔ 10	NO FUNCTION
	11 ↔ 30	RED 100% / GREEN UP / BLUE 0%
	31 ↔ 50	RED DOWN / GREEN 100% / BLUE 0%
	51 ↔ 70	RED 0% / GREEN 100% / BLUE UP
	71 ↔ 90	RED 0% / GREEN DOWN / BLUE 100%
	91 ↔ 110	RED UP / GREEN 0% / BLUE 100%
	111 ↔ 130	RED 100% / GREEN 0% / BLUE DOWN
	131 ↔ 150	RED 100% / GREEN UP / BLUE UP
	151 ↔ 170	RED DOWN / GREEN DOWN / BLUE 100%
	171 ↔ 195	ALL LEDS AT FULL OUTPUT
	196 ↔ 200	2700K
	201 ↔ 205	3000K
	206 ↔ 210	3200K
	211 ↔ 215	3500K
	216 ↔ 220	4000K
	221 ↔ 225	4200K
	226 ↔ 230	4500K
	231 ↔ 235	5600K
	236 ↔ 240	6000K
	241 ↔ 245	6500K
246 ↔ 250	7200K	
251 ↔ 255	8000K	
12		STROBE1
	0 ↔ 9	NO FUNCTION
	10 ↔ 255	0-25Hz
13	0 ↔ 255	Duration ( 14ms-650ms )