





## CD 78.26/245 8Ω

Compression Driver

1" | 32 W

Code Z009442

-  1" voice coil Kapton former
-  Tri-Acetate diaphragm
-  Ferrite Magnet Circuit
-  1" horn throat diameter
-  105.5 dB sensitivity

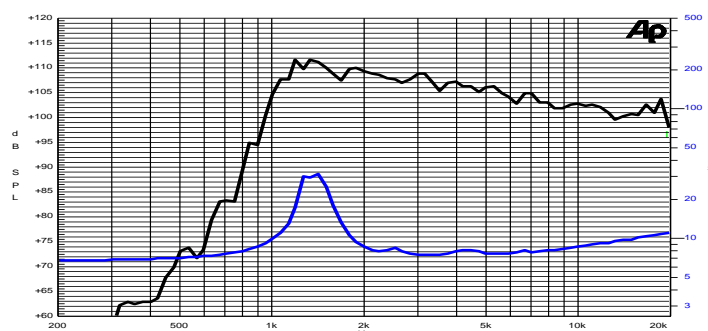
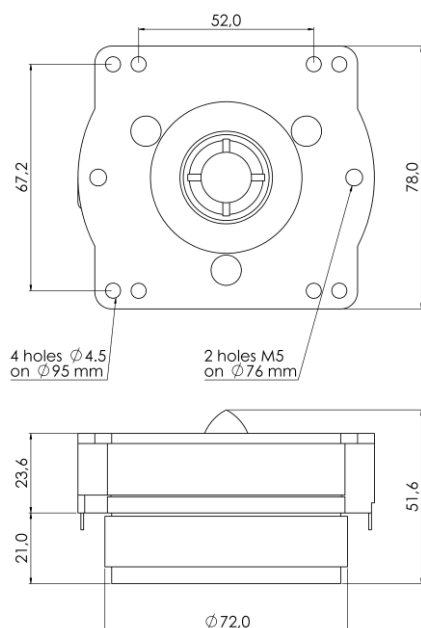

Free Air Frequency Response with 6x8 inches horn @ 1W, 1m Impedance (without horn)

### General Specifications

Nominal Diameter	78 mm
Nominal Impedance	8 Ω
Rated Power AES <sup>(1)</sup> (1500 – 20000 Hz)	16 W
Continuous Program Power <sup>(2)</sup>	32 W
Sensitivity @ 1W/1m <sup>(3)</sup>	105.5 dB
Voice Coil Diameter	25 mm (1")
Voice Coil Winding Depth	1.7 mm
Magnetic Gap Depth	2.0 mm
Flux Density	1.56 T
DC Resistance	6.3 Ω
Resonance Frequency	1.5 kHz
Magnet Weight	245 g
Net Weight	0.6 kg
Recommended Crossover Frequency	2.5 kHz
Throat Diameter	25.4 mm / 1 in

### Constructive Characteristics

Magnet	Ferrite
Voice Coil Winding Material	Copper
Voice Coil Former Material	Kapton
Diaphragm	Tri-acetate Film
Ferrofluid in Air Gap	No
Spare Part Code	Z009374

### Mounting Information

Overall Dimensions	78x88,5 mm
Mounting Holes	2 holes ø4,5 on ø95 mm
	2 holes M5 on ø76 mm
Total Depth	51.6 mm

(1) Rated Power measured with 2-hour test with pink noise signal, 6dB crest factor, driver coupled to the recommended horn. (2) Power on Continuous Program is defined as 3dB greater than the Rated Power. (3) Measured at 1W,1m in axis within the frequency range, driver coupled to the recommended horn